

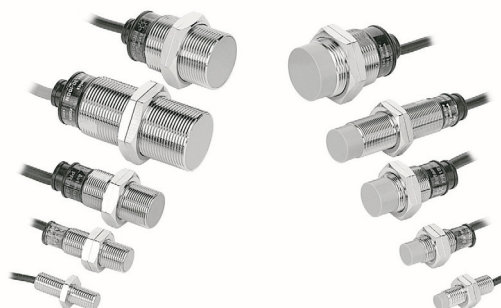

Cylindrical type proximity sensor

■ Features

- Enhanced noise-resistance by using exclusive IC (DC power)
- Upgraded DC2-wire type :
Residual voltage (Max. 4VDC), Control output range (2~100mA),
Operation voltage (10~30VDC)
- Polarity free DC2-wire type
- Reverse polarity protection and overload protection (DC),
surge absorption (DC/AC)
- Operation confirmed easily by a red indicator lamp
- Wide range of applications (for replacement of micro switch,
limit switch, etc.)
- IP67 (IEC standard)



 Please read "Caution for your safety" in operation manual before using.



■ Specifications

● DC 2-wire type

*A blacked () item is upgraded function.

Model (※1)	PRT08-1.5DO PRT08-1.5DC PRT08-1.5DO-NP PRT08-1.5DC-NP	PRT08-2DO PRT08-2DC PRT08-2DO-NP PRT08-2DC-NP	PRT12-2DO PRT12-2DC PRT12-2DO-NP PRT12-2DC-NP	PRT12-4DO PRT12-4DC PRT12-4DO-NP PRT12-4DC-NP	PRT18-5DO PRT18-5DC PRT18-5DO-NP PRT18-5DC-NP	PRT18-8DO PRT18-8DC PRT18-8DO-NP PRT18-8DC-NP	PRT30-10DO PRT30-10DC PRT30-10DO-NP PRT30-10DC-NP	PRT30-15DO PRT30-15DC PRT30-15DO-NP PRT30-15DC-NP
Detecting distance	1.5mm ±10%	2mm ±10%	2mm ±10%	4mm ±10%	5mm ±10%	8mm ±10%	10mm ±10%	15mm ±10%
Hysteresis	Max. 10% of detecting distance <input type="checkbox"/>							
Standard detecting target	8×8×1mm (Iron)		12×12×1mm (Iron)		18×18×1mm (Iron)	25×25×1mm (Iron)	30×30×1mm (Iron)	45×45×1mm (Iron)
Setting distance	0~1.05mm	0~1.4mm	0~1.4mm	0~2.8mm	0~3.5mm	0~5.6mm	0~7mm	0~10.5mm
Power supply (Operation voltage)	24VDC (10~30VDC)							
Leakage current	Max. 0.9mA							
Response frequency	800Hz			400Hz	350Hz	200Hz	250Hz	100Hz
Residual voltage (※2)	Max. 4V							
Affection by Temp.	±10% Max. for detecting distance at +20°C within temperature range of -25 ~ +70°C							
Control output	2~100mA							
Insulation resistance	Min. 50MΩ (at 500VDC)							
Dielectric strength	1500VAC 50/60Hz for 1minute							
Vibration	1mm amplitude at frequency of 10 ~ 55Hz in each of X, Y, Z directions for 2 hours							
Shock	500m/s ² (50G) in X, Y, Z direction for 3 times							
Indicator	Operation indicator (RED LED)							
Ambient temperature	-25 ~ +70°C (at non-freezing status)							
Storage temperature	-30 ~ +80°C (at non-freezing status)							
Ambient humidity	35 ~ 95%RH							
Protection circuit	Surge protection circuit, Overload & short circuit protection (except PRT08 series)							
Protection	IP67 (IEC specification)							
Cable spec.	φ 4 × 2P, 2m				φ 5 × 2P, 2m			
Approval	CE							
Weight	Approx. 36g	Approx. 36g	Approx. 63g	Approx. 63g	Approx. 122g	Approx. 122g	Approx. 181g	Approx. 181g

(※1) The "-NP" is for non-polar type.

(※2) For non-polar type, the residual voltage is below 5V.

(A)
Counter

(B)
Timer

(C)
Temp.
controller

(D)
Power
controller

(E)
Panel
meter

(F)
Tacho/
Speed/
Pulse
meter

(G)
Display
unit

(H)
Sensor
controller

(I)
Proximity
sensor

(J)
Photo
electric
sensor

(K)
Pressure
sensor

(L)
Rotary
encoder

(M)
5-Phase
stepping
motor &
Driver &
Controller

PR Series

● Specifications(DC 3-wire type)

Model	PR08-1.5DN PR08-1.5DP PR08-1.5DN2 PR08-1.5DP2 PRL08-1.5DN PRL08-1.5DP PRL08-1.5DN2 PRL08-1.5DP2	PR08-2DN PR08-2DP PR08-2DN2 PR08-2DP2 PRL08-2DN PRL08-2DP PRL08-2DN2 PRL08-2DP2	PR12-2DN PR12-2DP PR12-2DN2 PR12-2DP2 PRS12-2DN PRS12-2DP PRS12-2DN2	PR12-4DN PR12-4DP PR12-4DN2 PR12-4DP2 PRS12-4DN PRS12-4DP PRS12-4DN2	PR18-5DN PR18-5DP PR18-5DN2 PR18-5DP2 PRL18-5DN PRL18-5DP PRL18-5DN2 PRL18-5DP2	PR18-8DN PR18-8DP PR18-8DN2 PR18-8DP2 PRL18-8DN PRL18-8DP PRL18-8DN2 PRL18-8DP2	PR30-10DN PR30-10DP PR30-10DN2 PR30-10DP2 PRL30-10DN PRL30-10DP PRL30-10DN2 PRL30-10DP2	PR30-15DN PR30-15DP PR30-15DN2 PR30-15DP2 PRL30-15DN PRL30-15DP PRL30-15DN2 PRL30-15DP2
Detecting distance	1.5mm ±10%	2mm ±10%	2mm ±10%	4mm ±10%	5mm ±10%	8mm ±10%	10mm ±10%	15mm ±10%
Hysteresis	Max. 10% of detecting distance □							
Standard detecting target	8×8×1mm (Iron)		12×12×1mm (Iron)		18×18×1mm (Iron)	25×25×1mm (Iron)	30×30×1mm (Iron)	45×45×1mm (Iron)
Setting distance	0~1.05mm	0~1.4mm	0~1.4mm	0~2.8mm	0~3.5mm	0~5.6mm	0~7mm	0~10.5mm
Power supply (Operation voltage)	12-24VDC (10-30VDC)							
Current consumption	Max. 10mA							
Response frequency	800Hz		400Hz	350Hz	200Hz	250Hz	100Hz	
Residual voltage	Max. 2V		Max. 1.5V					
Affection by Temp.	±10% Max. for detecting distance at +20°C within temperature range of -25 ~ +70°C							
Control output	200mA							
Insulation resistance	Min. 50MΩ (at 500VDC)							
Dielectric strength	1500VAC 50/60Hz for 1minute							
Vibration	1mm amplitude at frequency of 10 ~ 55Hz in each of X, Y, Z directions for 2 hours							
Shock	500m/s ² (50G) in X, Y, Z direction for 3 times							
Indicator	Operation indicator (RED LED)							
Ambient temperature	-25 ~ +70°C (at non-freezing status)							
Storage temperature	-30 ~ +80°C (at non-freezing status)							
Ambient humidity	35 ~ 95%RH							
Protection circuit	Surge protection circuit, Overload & short circuit protection (except PR08 and PRS12 series)							
Protection	IP67 (IEC specification)							
Cable spec.	φ 4 × 3P, 2m				φ 5 × 3P, 2m			
Approval	CE							
Weight	Approx. 36g	Approx. 36g	PR: Approx. 70g PRS: Approx. 68g	PR: Approx. 70g PRS: Approx. 68g	PR: Approx. 119g PRS: Approx. 150g	PR: Approx. 118g PRS: Approx. 150g	PR: Approx. 184g PRS: Approx. 222g	PR: Approx. 181g PRS: Approx. 227g

● Specifications(AC 2-wire type)

Model	PR12-2AO PR12-2AC	PR12-4AO PR12-4AC	PR18-5AO PR18-5AC PRL18-5AO PRL18-5AC	PR18-8AO PR18-8AC PRL18-8AO PRL18-8AC	PR30-10AO PR30-10AC PRL30-10AO PRL30-10AC	PR30-15AO PR30-15AC PRL30-15AO PRL30-15AC
Detecting distance	2mm ±10%	4mm ±10%	5mm ±10%	8mm ±10%	10mm ±10%	15mm ±10%
Hysteresis	Max. 10% of detecting distance □					
Standard detecting target	12×12×1mm (Iron)		18×18×1mm (Iron)	25×25×1mm (Iron)	30×30×1mm (Iron)	45×45×1mm (Iron)
Setting distance	0~1.4mm	0~2.8mm	0~3.5mm	0~5.6mm	0~7mm	0~10.5mm
Power supply (Operation voltage)	100-240VAC (85-264VAC)					
Current consumption	Max. 2.5mA					
Response frequency	20Hz					
Residual voltage	Max. 10V					
Affection by Temp.	±10% Max. for detecting distance at +20°C within temperature range of -25 ~ +70°C					
Control output	5~150mA			5~200mA		
Insulation resistance	Min. 50MΩ (at 500VDC)					
Dielectric strength	2500VAC 50/60Hz for 1minute					
Vibration	1mm amplitude at frequency of 10 ~ 55Hz in each of X, Y, Z directions for 2 hours					
Shock	500m/s ² (50G) in X, Y, Z direction for 3 times					
Indicator	Operation indicator (RED LED)					
Ambient temperature	-25 ~ +70°C (at non-freezing status)					
Storage temperature	-30 ~ +80°C (at non-freezing status)					
Ambient humidity	35 ~ 95%RH					
Protection circuit	Surge protection circuit built-in					
Protection	IP67 (IEC specification)					
Cable spec.	φ 4 × 2P, 2m			φ 5 × 2P, 2m		
Approval	CE					
Weight	Approx. 66g	Approx. 66g	PR : Approx. 130g PRS : Approx. 150g	PR : Approx. 130g PRS : Approx. 150g	PR : Approx. 185g PRS : Approx. 224g	PR : Approx. 117g PRS : Approx. 222g

Cylindrical Type

Dimensions

Unit:mm

●PR(T)08-1.5D□

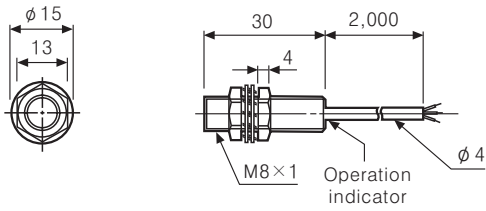

●PR(T)08-2D□

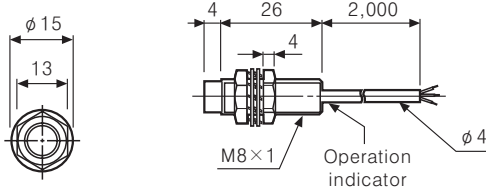

●PR(T)18-5D□

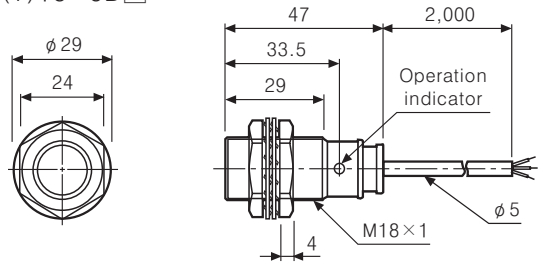

●PR(T)18-8D□

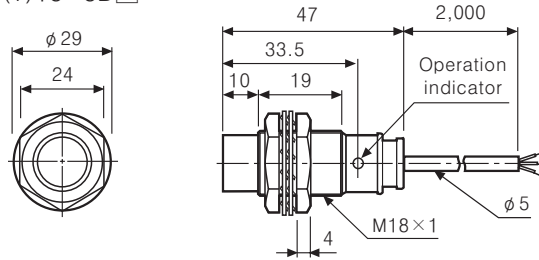

●PRS12-2D□

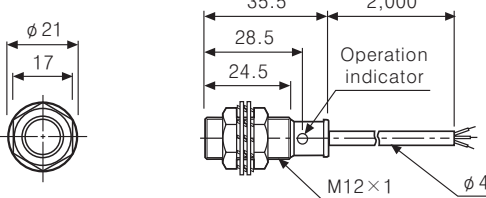

●PRS12-4D□

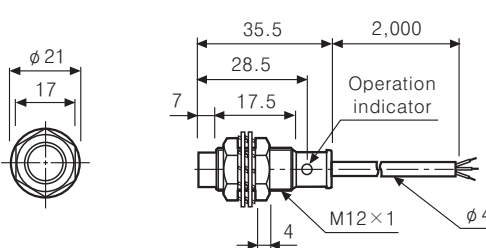

●PR(T)30-10D□

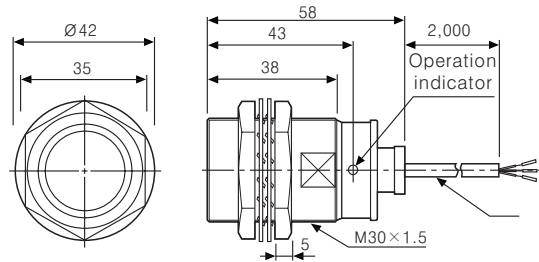

●PR(T)30-15D□

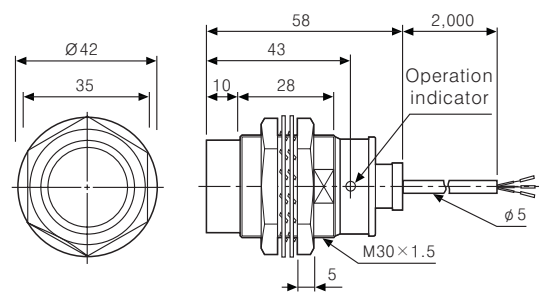

●PR(T)12-2D□

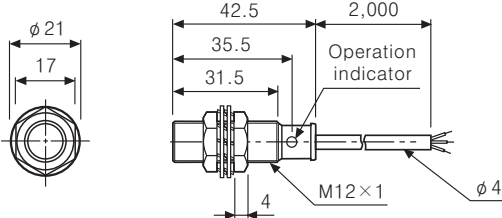

●PR(T)12-4D□

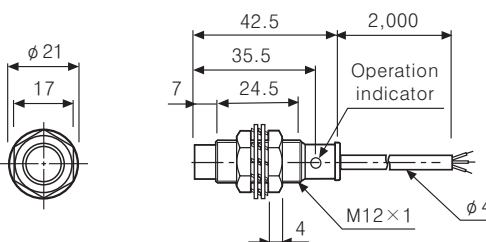

●PRL08-1.5D□

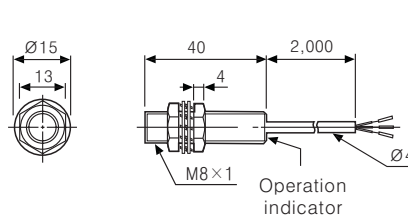

●PRL08-2D□

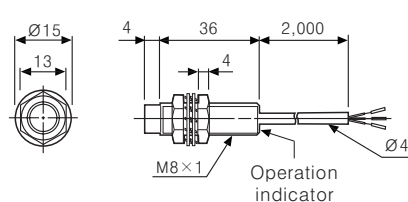

(A)
Counter

(B)
Timer

(C)
Temp.
controller

(D)
Power
controller

(E)
Panel
meter

(F)
Tacho/
Speed/
Pulse
meter

(G)
Display
unit

(H)
Sensor
controller

(I)
Proximity
sensor

(J)
Photo
electric
sensor

(K)
Pressure
sensor

(L)
Rotary
encoder

(M)
5-Phase
stepping
motor &
Driver &
Controller

PR Series

Dimensions

Unit:mm

●PRL12-4DN ●PRL12-4DP

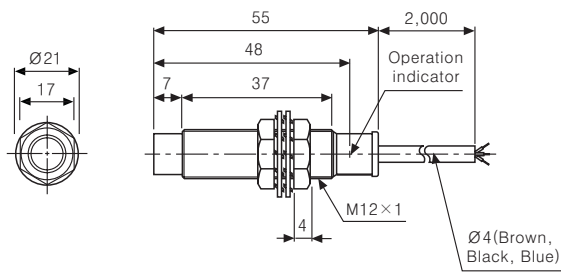

●PR12-2A□

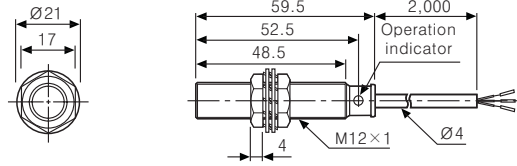

●PR12-4A□

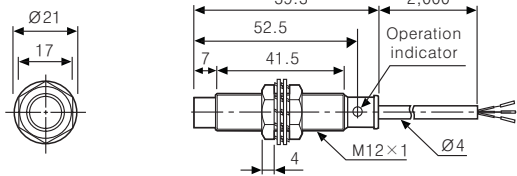

●PRL18-5D□ ●PRL18-5A□

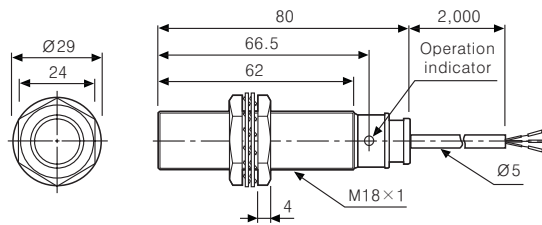

●PR18-5A□

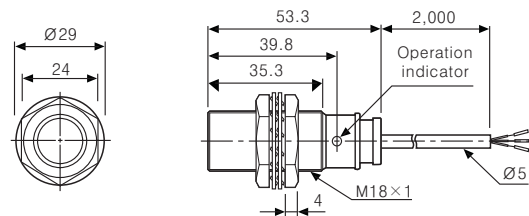

●PRL18-8D□ ●PRL18-8A□

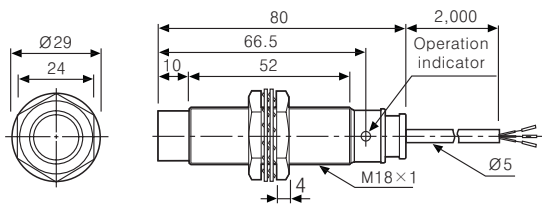

●PR18-8A□

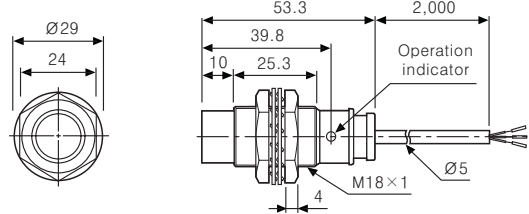

●PRL30-10D□ ●PRL30-10A□

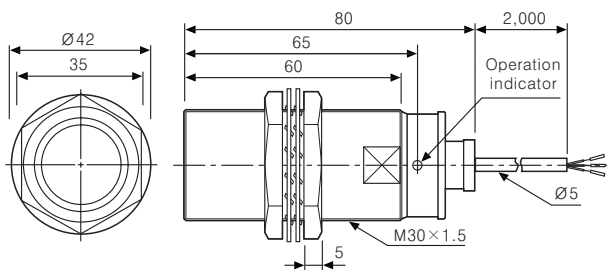

●PR30-10A□

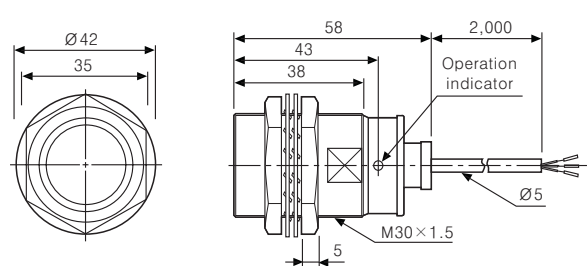

●PRL30-15D□ ●PRL30-15A□

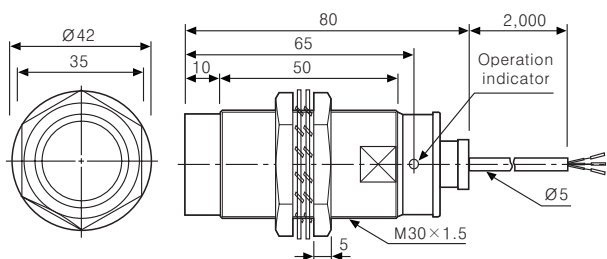

●PR30-15A□

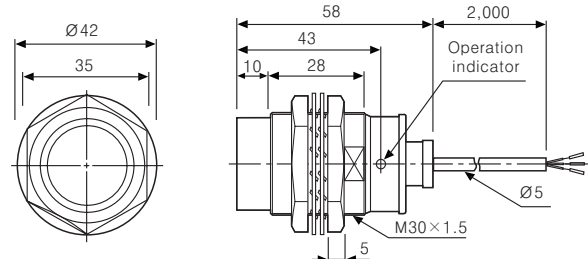

Cylindrical Type

Control output diagram

DC 2-wire type

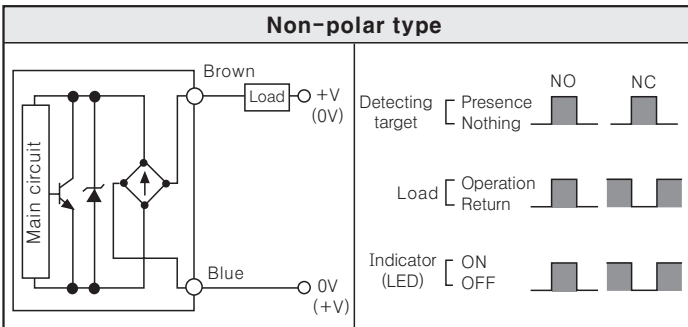
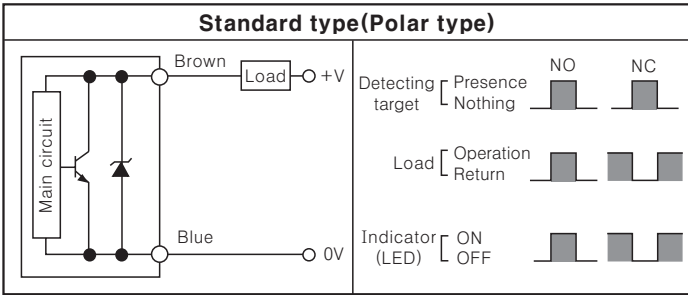

DC 3-wire type

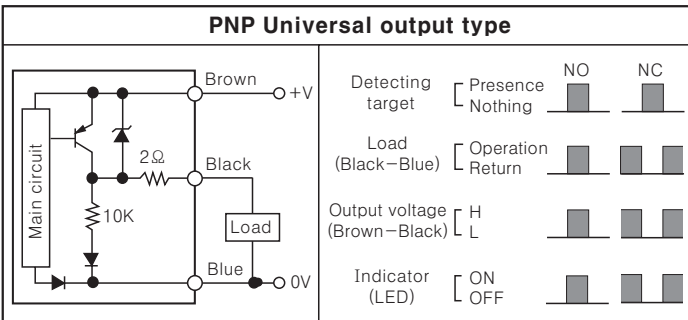
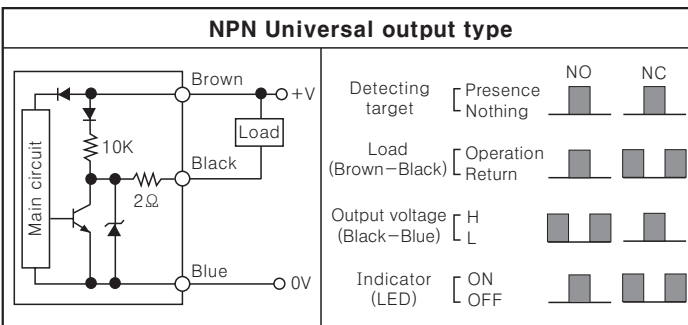

AC 2-wire type

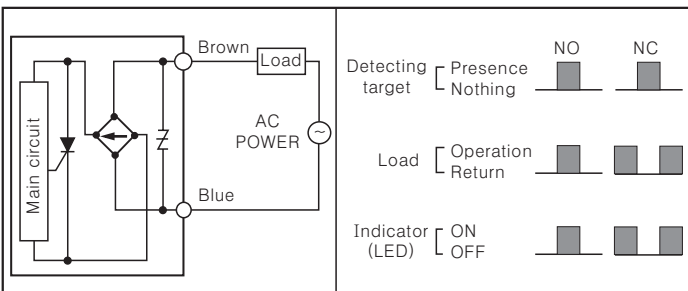

Connections

DC 2-wire type

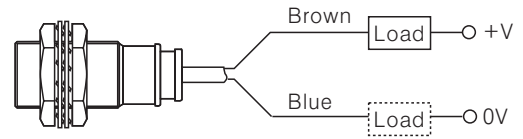

*The load is connectable without affecting polarity.

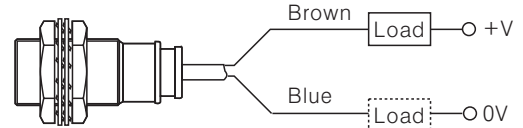

*Load can be connected to either wire.

DC 3-wire type

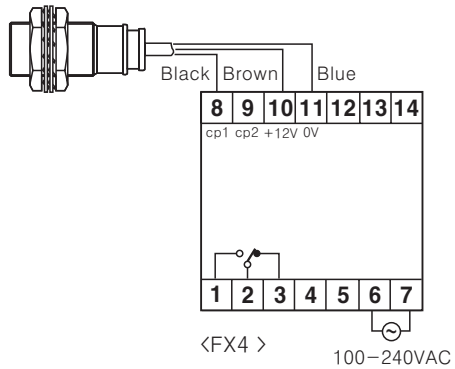
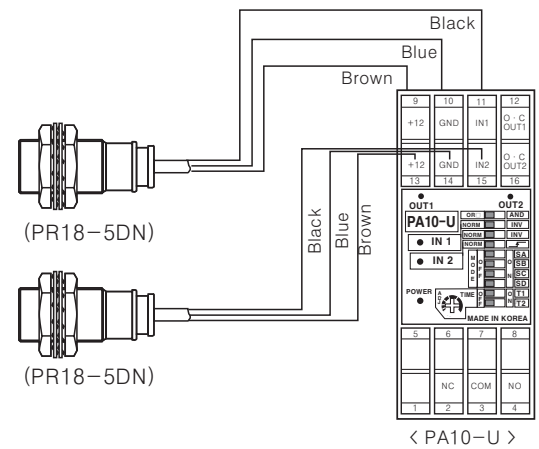

AC 2-wire type

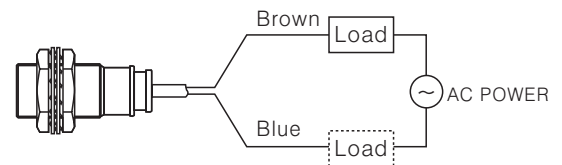

*The load is connectable without affecting polarity.

(A) Counter

(B) Timer

(C) Temp. controller

(D) Power controller

(E) Panel meter

(F) Tacho/Speed/Pulse meter

(G) Display unit

(H) Sensor controller

(I) Proximity sensor

(J) Photo electric sensor

(K) Pressure sensor

(L) Rotary encoder

(M) 5-Phase stepping motor & Driver & Controller

PR Series

■ Proper usage

◎ Load connections

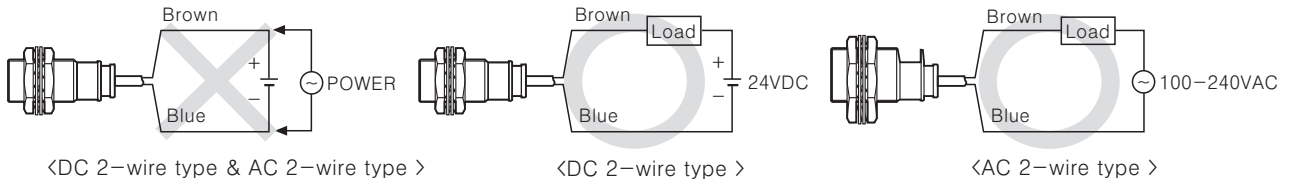

When using DC or AC 2-wire type proximity sensor, the load must be connected otherwise internal components may be damaged. And the load can be connected to either wire.

◎ In case of the load current is small

● AC 2-wire type

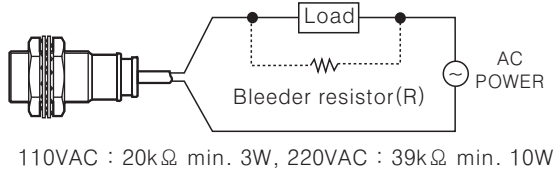

It may cause return failure of load by residual voltage. If the load current is under 5mA, please make sure the residual voltage is less than the return voltage of the load by connecting a bleeder resistor in parallel with the load as shown in the diagram.

● DC 2-wire type

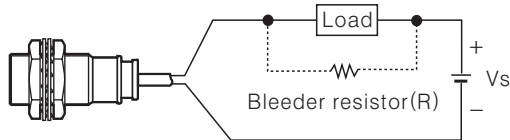

Please make the current on proximity sensor smaller than the return current of load by connecting a bleeder resistor in parallel.

※ W value of Bleeder resistor should be bigger for proper heat dissipation.

$$R \leq \frac{V_s}{I_o - I_{off}} \text{ (k}\Omega\text{)} \quad * V_s : \text{Power supply}$$

$$P > \frac{V_s^2}{R} \text{ (mW)}$$

P : Bleeder resistor, number of W
 I_o : Operating current 2mA of proximity sensor
 I_{off} : Return current of load

◎ Mutual-interference & Influence by surrounding metals

● Mutual-interference

When several proximity sensors are mounted close together, malfunction of sensor may be caused due to mutual interference. Therefore, be sure to provide a minimum distance between the two sensors, as below charts.

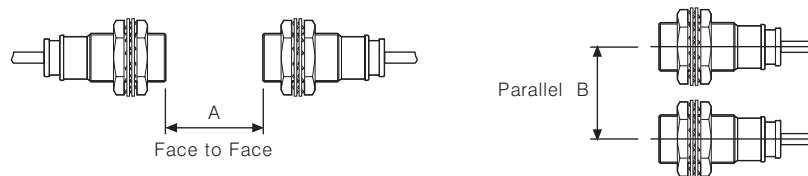

● Influence by surrounding metals

When sensors are mounted on metallic panel, you must prevent the sensors from being affected by any metallic object except target. Therefore, be sure to provide a minimum distance as below chart.

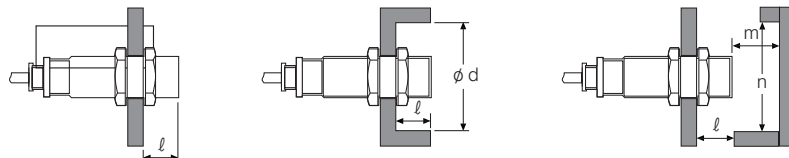

Unit:mm

Model	PR08-1.5D□ PRT08-1.5D□	PR08-2D□ PRT08-2D□	PR(T)12-2D□ PRS12-2D□ PR12-2A□	PR(T)12-4D□ PRS12-4D□ PR12-4A□	PR(T)18-5D□ PRL18-5D□ PR18-5A□ PRL18-5A□	PR(T)18-8D□ PRL18-8D□ PR18-8A□ PRL18-8A□	PR(T)30-10D□ PR30-10A□ PRL30-10A□	PR(T)30-15D□ PR30-15A□ PRL30-15A□
A	9	12	12	24	30	48	60	90
B	16	24	24	36	36	54	60	90
l	0	8	0	11	0	14	0	15
φ d	8	24	12	36	18	54	30	90
m	4.5	6	6	12	15	24	30	54
n	12	24	18	36	27	54	45	90