

# UKF7 Earth Leakage Circuit Breaker

UKF7 漏电保护开关



## Technology Specification

### 技术参数

符合标准 Conform to standard	IEC1008(EN61008)、GB/T 16916.1
漏电动作时间 Earth leakage motion time	<input type="checkbox"/> 非延时 <input checked="" type="checkbox"/> 最少10ms延时 <input type="checkbox"/> 最少40ms延时, 选择性 <input type="checkbox"/> Non-Extent time G Least 10ms Extent time S Least 40ms, Exteng time, selectivity6-40A
额定电压(Ue) Rated voltage	230/400V; 50/60Hz
额定电流(In) Rated current Rated current	16,25,40,63A
额定漏电流(In) Rated earth leakage current	10,30,100,300,500mA
灵敏性 Be sensitive to capability	<input checked="" type="checkbox"/> AC型 AC Type <input type="checkbox"/> A型 A Type
短时耐受电流 Brief while able current	10kA-接 63A gI 熔断器 Contactor 63A Fuse 10kA-接 80A gI 熔断器(F7-80) Contactor 80A Fuse(F7-80)
抗气候条件能力 Resist clime condition power	按IEC1008标准 Standard of IEC1008
外壳防护等级 Case protection grade	IP40(安装后) IP40 (Install after)
电气寿命 Electrical life	不少于4000次(通-断) Not less of 4000 times switching operation
机械寿命 Moto life	不少于20000次(通-断) Not less of 20000 times switching operation

# UKF7 Earth Leakage Circuit Breaker

## UKF7 漏电保护开关

### Mechanical Parameters

#### 机械参数

安装方式 Installation mode	采用IEC标准导轨安装 The standard IEC rail
端子接线能力 Terminal block capability	导线1-25mm <sup>2</sup> ; 母线排厚离0.8-2mm Conductor 1-25mm <sup>2</sup> ; Generatrix thickness 0.8-2mm
外壳宽度 Enclosure width	二级35mm <sup>2</sup> ; 四级70mm (2 pole)35mm; (4 pole)70mm

### Outline and Installaiton Dimensions

#### 外形与安装尺寸

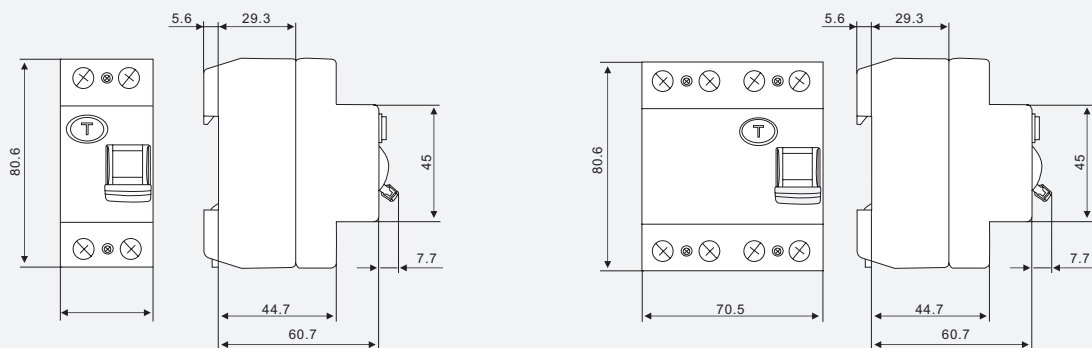

除另外声明：2极开关是两个模数宽，4极（3P+N）是四个模数宽

Unless specified otherwise: The width of two-step switch is two modulus, Four-step(3P+N) is four modulus

### Main Feature

#### 主要特点

两侧双功能接线端子，可同时接母线排和单芯导线

Bilateral double-functional wiring terminal can connect generatrix and single core wire.

具有触头状态指示器

With contactor condition indicator

多种漏电动作电流规格，容易实现选择性保护

Various current specifications of creepage action can easily ensure selective protection.

可防止由于电子设备开关操作引起的误动作

For prevention from unexpected trip due to switch operations of electric equipment

# UKF7 Earth Leakage Circuit Breaker

## UKF7 漏电保护开关

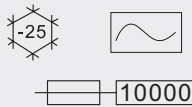
<p>动作功能与主线路电压无关，适用于漏电保护和附加保护。</p> <p>Motion function is not related to main circuit voltage, suitable for leakage or auxiliary protection.</p>  <p>可防止电子设备开关操作引起的不必要脱扣动作。</p> <p>To prevent the false tripping caused by the switching operation of electrical equipment.</p>	2P			4P		
	额定电流(A) Rated current(A)	额定漏电流 Rated leakage current		额定电流(A) Rated current(A)	额定漏电流 Rated leakage current	
	16	0.01	UKF7-63/2/16/0.01	25	0.03	UKF7-63/4/25/0.03
25	0.03	UKF7-63/2/25/0.03	25	0.10	UKF7-63/4/25/0.10	
25	0.10	UKF7-63/2/25/0.10	40	0.03	UKF7-63/4/40/0.03	
40	0.03	UKF7-63/2/40/0.03	40	0.10	UKF7-63/4/40/0.10	
40	0.10	UKF7-63/2/40/0.10	40	0.30	UKF7-63/4/40/0.30	
63	0.03	UKF7-63/2/63/0.03	40	0.50	UKF7-63/4/40/0.50	
63	0.10	UKF7-63/2/63/0.10	63	0.03	UKF7-63/4/63/0.03	
63	0.30	UKF7-63/2/63/0.30	63	0.10	UKF7-63/4/63/0.10	
80	0.03	UKF7-80/2/80/0.03	63	0.30	UKF7-63/4/63/0.30	
80	0.10	UKF7-80/2/80/0.10	63	0.50	UKF7-63/4/63/0.50	
80	0.30	UKF7-80/2/80/0.30	80	0.03	UKF7-80/4/80/0.03	
			80	0.10	UKF7-80/4/80/0.10	
			80	0.30	UKF7-80/4/80/0.30	
			80	0.50	UKF7-80/4/80/0.50	

<p>动作功能与主线路电压无关，适用于漏电保护和附加保护。</p> <p>Motion function is not related to main circuit voltage, suitable for leakage or auxiliary protection.</p>  <p>可防止电子设备开关操作引起的不必要脱扣动作。</p> <p>To prevent the false tripping caused by the switching operation of electrical equipment.</p>	2P			4P		
	额定电流(A) Rated current(A)	额定漏电流 Rated leakage current		额定电流(A) Rated current(A)	额定漏电流 Rated leakage current	
	16	0.01	UKF7-63/2/16/0.01	25	0.03	UKF7-63/4/25/0.03
25	0.03	UKF7-63/2/25/0.03	25	0.10	UKF7-63/4/25/0.10	
25	0.10	UKF7-63/2/25/0.10	40	0.03	UKF7-63/4/40/0.03	
40	0.03	UKF7-63/2/40/0.03	40	0.10	UKF7-63/4/40/0.10	
40	0.10	UKF7-63/2/40/0.10	40	0.30	UKF7-63/4/40/0.30	
63	0.03	UKF7-63/2/63/0.03	40	0.50	UKF7-63/4/40/0.50	
63	0.10	UKF7-63/2/63/0.10	63	0.03	UKF7-63/4/63/0.03	
63	0.30	UKF7-63/2/63/0.30	63	0.10	UKF7-63/4/63/0.10	
80	0.03	UKF7-80/2/80/0.03	63	0.30	UKF7-63/4/63/0.30	
80	0.10	UKF7-80/2/80/0.10	63	0.50	UKF7-63/4/63/0.50	
80	0.30	UKF7-80/2/80/0.30	80	0.03	UKF7-80/4/80/0.03	
			80	0.10	UKF7-80/4/80/0.10	
			80	0.30	UKF7-80/4/80/0.30	
			80	0.50	UKF7-80/4/80/0.50	

# UKF7 Earth Leakage Circuit Breaker

## UKF7 漏电保护开关

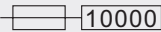
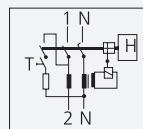
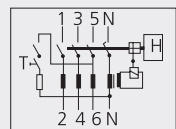
<p>动作功能与主线路电压无关，适用于漏电保护和附加保护。</p> <p>Motion function is not related to main circuit voltage, suitable for leakage or auxiliary protection.</p>   <p>可防止电子设备开关操作引起的不必要脱扣动作。</p> <p>To prevent the false tripping caused by the switching operation of electrical equipment.</p>	2P		4P		 
	额定电流(A) Rated current(A)	额定漏电流 Rated leakage current	额定电流(A) Rated current(A)	额定漏电流 Rated leakage current	
	25	0.03	UKF7-40/2/25/0.03-G	40	
25	0.10	UKF7-40/2/25/0.10-G	40	0.10	UKF7-40/4/25/0.10-G
40	0.03	UKF7-40/2/40/0.03-G	63	0.03	UKF7-63/4/63/0.03-G
40	0.10	UKF7-40/2/40/0.10-G	63	0.10	UKF7-63/4/63/0.10-G
			80	0.03	UKF7-80/4/80/0.03-G
			80	0.10	UKF7-80/4/80/0.10-G

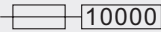
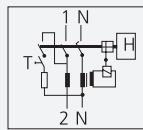
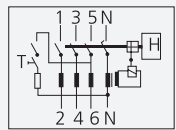
<p>动作功能与主线路电压无关，适用于漏电保护和附加保护。</p> <p>Motion function is not related to main circuit voltage, suitable for leakage or auxiliary protection.</p>   <p>可防止电子设备开关操作引起的不必要脱扣动作。</p> <p>To prevent the false tripping caused by the switching operation of electrical equipment.</p>	2P		4P		 
	额定电流(A) Rated current(A)	额定漏电流 Rated leakage current	额定电流(A) Rated current(A)	额定漏电流 Rated leakage current	
	40	0.10	UKF7-40/2/40/0.10-G	25	
40	0.30	UKF7-40/2/40/0.30-G	25	0.10	UKF7-63/4/25/0.10-S/A
			40	0.10	UKF7-63/4/40/0.10-S
			40	0.10	UKF7-63/4/40/0.10-S/A
			40	0.30	UKF7-63/4/40/0.30-S
			40	0.30	UKF7-63/4/40/0.30-S/A
			63	0.10	UKF7-63/4/63/0.10-S
			63	0.10	UKF7-63/4/63/0.10-S/A
			63	0.30	UKF7-63/4/63/0.30-S
			63	0.30	UKF7-63/4/63/0.30-S/A
			80	0.10	UKF7-80/4/80/0.10-S
			80	0.10	UKF7-80/4/80/0.10-S/A
			80	0.30	UKF7-80/4/80/0.30-S
			80	0.30	UKF7-80/4/80/0.30-S/A