

EMC TEST REPORT

For

Shenzhen New Huayi Instrument Co., Ltd

DIGITAL TACHOMETER

Model No.: MS6208A, MS6208B

Prepared for : Shenzhen New Huayi Instrument Co., Ltd
Address : F3, Block 2, Instrument World Industrial Park, Guiyue Road, Longhua New District, Shenzhen City

Prepared by : LiTest Technology Service Co., Ltd.
Address : No.42 FuKang Road, HouJie Town DongGuan City, GuangDong Province, China

Tel: +86-769-82272566
Fax: +86-769-82272565
Email:service@litest.cn

Report No. : 16LTE030928E
Date of Test : March 9-18, 2016
Date of Report : March 21, 2016

Table of Contents

Description	Page
TEST REPORT VERIFICATION	6
1 SUMMARY OF TEST RESULTS	7
1.1 DESCRIPTION OF STANDARDS AND RESULTS	7
2 GENERAL INFORMATION	8
2.1 Description of Device (EUT)	8
2.2 Tested Supporting System Details	9
2.3 Block Diagram of connection between EUT and simulators	9
2.4 Test Facility	10
2.4.1 Laboratory Name:	10
2.4.2 Site Location	10
2.4.3 Test facility:	10
2.5 Measurement Uncertainty	10
3 CONDUCTED DISTURBANCE AT MAINS TERMINALS TEST	11
3.1 Test Equipment	11
3.2 Block Diagram of Test Setup	11
3.3 Test Standard	11
3.4 Power Line Conducted Disturbance at Mains Terminals Limit	11
3.5 EUT Configuration on Test	12
3.5.1 Support Equipment :	12
3.6 Operating Condition of EUT	12
3.6.1 Setup the EUT and simulator as shown as Section 3.2.	12
3.6.2 Turn on the power of all equipment	12
3.6.3 Let EUT work in test modes and measure it.	12
3.7 Test Procedure	12
3.8 Conducted Disturbance At Mains Terminals Test Results	12
4 RADIATED DISTURBANCE TEST	13
4.1 Test Equipments	13
4.1.1 For Frequency Range 30MHz~1000 MHz (At Semi Anechoic Chamber)	13
4.1.2 For Frequency Range 1GHz~6 GHz (At Semi Anechoic Chamber)	13
4.2 Block Diagram Of Test Setup	13
4.2.1 In Semi Anechoic Chamber (3m) Test Setup Diagram For 30MHz~1000MHz	13
4.2.2 In Semi Anechoic Chamber (3m) Test Setup Diagram for 1-6GHz	14
4.3 Test Standard	14
4.4 Radiated Disturbance Limit	14
4.5 EUT Configuration on Test	15
4.6 Operating Condition of EUT	15
4.6.1 Setup the EUT and simulator as shown as Section 4.2.	15
4.6.2 Turned on the power of all equipment	15
4.6.3 Let EUT work in test modes and measure it.	15
4.7 Test Procedure	15
4.8 Radiated Disturbance Test Results	16
5 HARMONIC CURRENT TEST	19
5.1 Test Equipments	19
5.2 Block Diagram of Test Setup	19

5.3	Test Standard	19
5.4	Limits of Harmonic Current	19
5.5	Operating Condition of EUT	20
5.6	Test Procedure	21
5.7	Test Results	21
6	VOLTAGE FLUCTUATIONS & FLICKER TEST	22
6.1	Test Equipment	22
6.2	Block Diagram of Test Setup	22
6.3	Test Standard	22
6.4	Limits of Voltage Fluctuation and Flick	22
6.5	Operating Condition of EUT	22
6.6	Test Procedure	22
6.7	Test Results	22
7	IMMUNITY PERFORMANCE CRITERIA	23
8	ELECTROSTATIC DISCHARGE IMMUNITY TEST	24
8.1	Test Equipments	24
8.2	Block Diagram of Test Setup	24
8.3	Test Standard	24
8.4	Severity Levels and Performance Criterion	24
8.4.1	Severity level	24
8.4.2	Performance criterion : B	24
8.5	EUT Configuration	25
8.6	Operating Condition of EUT	25
8.7	Test Procedure	25
8.7.1	Air Discharge:	25
8.7.2	Contact Discharge:	25
8.7.3	Indirect discharge for horizontal coupling plane:	25
8.7.4	Indirect discharge for vertical coupling plane:	25
8.8	Test Results	25
9	RF FIELD STRENGTH SUSCEPTIBILITY TEST	27
9.1	Test Equipments	27
9.2	Block Diagram of Test Setup	27
9.3	Test Standard	28
9.4	Severity Levels and Performance Criterion	28
9.4.1	Limit	28
9.4.2	Severity level	28
9.4.3	Performance criterion : A	28
9.5	EUT Configuration	28
9.6	Operating Condition of EUT	28
9.7	Test Procedure	29
9.8	Test Results	29
10	ELECTRICAL FAST TRANSIENT/BURST IMMUNITY TEST	33
10.1	Test Equipments	33
10.2	Block Diagram of Test Setup	33
10.3	Test Standard	33
10.4	Severity Levels and Performance Criterion	33
10.4.1	Severity level	33

10.4.2	Performance criterion : B	33
10.5	EUT Configuration	34
10.6	Operating Condition of EUT	34
10.7	Test Procedure	34
10.7.1	For input and AC power ports:	34
10.7.2	For signal lines and control lines ports:.....	34
10.7.3	For DC input and DC output power ports:.....	34
10.8	Test Results.....	34
11	SURGE TEST	35
11.1	Test Equipments.....	35
11.2	Block Diagram of Test Setup	35
11.3	Test Standard	35
11.4	Severity Levels and Performance Criterion.....	35
11.4.1	Severity level	35
11.4.2	Performance criterion: B	35
11.5	EUT Configuration	36
11.6	Operating Condition of EUT	36
11.7	Test Procedure	36
11.8	Test Results.....	36
12	INJECTED CURRENTS SUSCEPTIBILITY TEST.....	37
12.1	Test Equipments.....	37
12.2	Block Diagram of Test Setup	37
12.3	Test Standard	37
12.4	Severity Levels and Performance Criterion.....	37
12.4.1	Severity level	37
12.4.2	Performance criterion: A	37
12.5	EUT Configuration	38
12.6	Operating Condition of EUT	38
12.7	Test Procedure	38
12.8	Test Results.....	38
13	MAGNETIC FIELD IMMUNITY TEST	39
13.1	Test Equipments.....	39
13.2	Block Diagram of Test Setup	39
13.3	Test Standard	39
13.4	Severity Levels and Performance Criterion.....	39
13.4.1	Severity level	39
13.4.2	Performance criterion : A	39
13.5	EUT Configuration on Test	40
13.6	Operating Condition of EUT.....	40
13.7	Test Procedure	40
13.8	Test Results.....	40
14	VOLTAGE DIPS AND INTERRUPTIONS TEST	41
14.1	Test Equipment.....	41
14.2	Block Diagram of Test Setup	41
14.3	Test Standard	41
14.4	Severity Levels and Performance Criterion.....	41
14.4.1	Severity level	41
14.4.2	Performance criterion : B & C	41

14.5	EUT Configuration	42
14.6	Operating Condition of EUT	42
14.7	Test Procedure	42
14.8	Test Results	42
15	PHOTOGRAPHS OF THE TEST CONFIGURATION	43
15.1	Photos of Radiated Emission Test (In Anechoic Chamber)	43
15.2	Photos of Electrostatic Discharge Immunity Test.....	44
16	PHOTOS OF THE EUT	45

TEST REPORT VERIFICATION

Applicant : Shenzhen New Huayi Instrument Co., Ltd

Manufacturer : Shenzhen New Huayi Instrument Co., Ltd

EUT Description : DIGITAL TACHOMETER

(A) Model No :	MS6280A, MS6208B
(B) Trademark :	PEAKMETER
(C) Power Supply:	--
(D) Test Voltage :	DC 6V From Battery

Measurement Standard Used:

EN 61326-1: 2013



EN 61326-2-2: 2013

(IEC 61000-4-2:2008, IEC 61000-4-3:2006+A1:2007+A2:2010)

The device described above is tested by LiTest Technology Service Co., Ltd.. to determine the maximum emission levels emanating from the device and the severe levels of the device can endure and its performance criterion. The test results are contained in this test report and LiTest Technology Service Co., Ltd. is assumed full responsibility for the accuracy and completeness of test. Also, this report shows that the EUT is technically compliant with the EN 61326-1 and EN 61326-2-2 requirements.

This report applies to above tested sample only.

Report of date..... : March 21, 2016

Tested by (name + signature).....: Approved by (name + signature)..... : 

1 SUMMARY OF TEST RESULTS

1.1 DESCRIPTION OF STANDARDS AND RESULTS

The EUT have been tested according to the applicable standards as referenced below

EMISSION				
Description of Test Item	Standard	Limits		Results
Conducted disturbance at mains terminals	EN 61326-1: 2013	Class B		N/A
Conducted disturbance at telecommunication port	EN 61326-1: 2013	Class B		N/A
Radiated disturbance	EN 61326-1: 2013	Class B		PASS
Harmonic current emissions	EN 61000-3-2:2014	Class A		N/A
Voltage fluctuations & flicker	EN 61000-3-3:2013	Section 5		N/A
IMMUNITY (EN 61326-2-2: 2013)				
Description of Test Item	Basic Standard	Performance Criteria	Observation Criteria	Results
Electrostatic discharge (ESD)	IEC 61000-4-2:2008	B	B	PASS
Radio-frequency, Continuous radiated disturbance	IEC 61000-4-3:2006 +A1:2007+ A2:2010	A	A	PASS
Electrical fast transient (EFT)	IEC 61000-4-4:2012	B	N/A	N/A
Surge (Input a.c. power port)	IEC 61000-4-5:2014	B	N/A	N/A
Surge(Telecommunication port)		B	N/A	N/A
Radio-frequency, Continuous conducted disturbance	IEC 61000-4-6:2013	A	N/A	N/A
Power frequency magnetic field	IEC 61000-4-8:2009	A	N/A	N/A
Voltage dips, >95% reduction	IEC 61000-4-11:2004	B	N/A	N/A
Voltage dips, 30% reduction		B	N/A	N/A
Voltage interruptions		C	N/A	N/A
N/A is an abbreviation for Not Applicable. The product intended for use in industrial locations.				

2 GENERAL INFORMATION

2.1 Description of Device (EUT)

DESCRIPTION	:	DIGITAL TACHOMETER
--------------------	---	--------------------

MODEL NO.	:	MS6208A, MS6208B
DIFF.	:	There's no difference between the models except the appearance, so all the test were performed on the model MS6208B.

TRADEMARK	:	PEAKMETER
------------------	---	-----------

APPLICANT	:	Shenzhen New Huayi Instrument Co., Ltd
ADDRESS	:	F3, Block 2, Instrument World Industrial Park, Guiyue Road, Longhua New District, Shenzhen City

MANUFACTURER:	Shenzhen New Huayi Instrument Co., Ltd	
ADDRESS	:	F3, Block 2, Instrument World Industrial Park, Guiyue Road, Longhua New District, Shenzhen City

SAMPLE TYPE	:	Prototype production
--------------------	---	----------------------

2.2 Tested Supporting System Details

NO.	DESCRIPTION	MANUFACTURER	MODEL	SERIAL NUMBER
1.	-	N/A	N/A	N/A

SIGNAL CABLE DESCRIPTION OF THE ABOVE SUPPORT UNITS					
NO.	PORT NAME	CABLE	LENGTH	SHIELDED (YES OR NO)	DETACHABLE (YES OR NO)
1	N/A	N/A	N/A	N/A	N/A

2.3 Block Diagram of connection between EUT and simulators

FOR EMI TESTS



FOR EMS TEST



※ EUT: DIGITAL TACHOMETER

2.4 Test Facility

2.4.1 Laboratory Name:

Keyway Testing Technology Co., Ltd.

2.4.2 Site Location

Baishun Industrial Zone, Zhangmutou Town, Dongguan, Guangdong, China

2.4.3 Test facility:

Certificated by Industry Canada
Registration No.: 9868A
Date of registration: December 8, 2011

Certificated by FCC, USA
Registration No.: 370994
Date of registration: January 8, 2015

Certificated by CNAS China
Registration No.: CNAS L5783
Date of registration: September 13, 2015

2.5 Measurement Uncertainty

Measurement	Uncertainty
Conducted emissions	$\pm 2.60\text{dB}$
Radiated emissions	$\pm 3.20\text{dB}$

3 CONDUCTED DISTURBANCE AT MAINS TERMINALS TEST

3.1 Test Equipment

Equipment	Manufacturer	Model No.	Serial No.	Last Cal.	Next Cal.
EMI Test Receiver	Rohde&Schwarz	ESCI	101156	Apr. 27,15	Apr. 27,16
Artificial Mains Network	Rohde&Schwarz	ENV216	101315	Apr. 27,15	Apr. 27,16
Artificial Mains Network (AUX)	Rohde&Schwarz	ENV216	101314	Apr. 27,15	Apr. 27,16
RF Cable	FUJIKURA	3D-2W	944 Cable	Apr. 27,15	Apr. 27,16
Voltage Probe	PHX	A130302	KWE-053	Apr. 27,15	Apr. 27,16
Coupling/Decoupling Network	FRANKONIA	A3011081	KWE-0534	Apr. 27,15	Apr. 27,16

3.2 Block Diagram of Test Setup

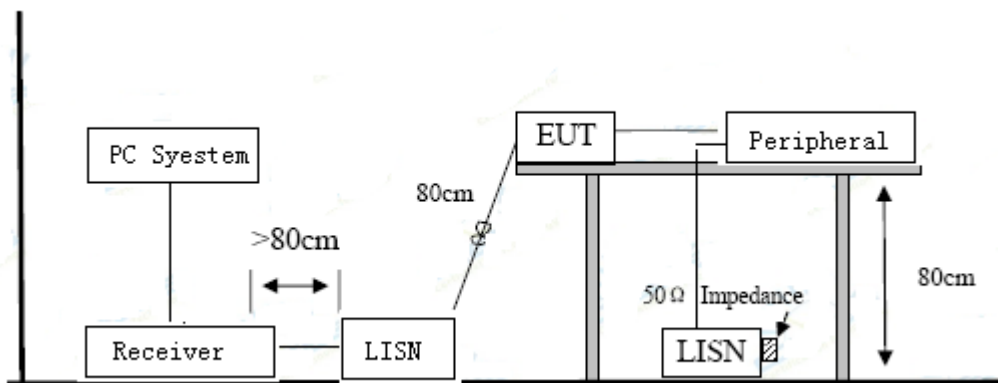

3.3 Test Standard

EN 61326-1: 2013

3.4 Power Line Conducted Disturbance at Mains Terminals Limit

FREQUENCY	MAXIMUM RF LINE VOLTAGE	
	Quasi-Peak Level dB(μV)	Average Level dB(μV)
150kHz ~ 500kHz	66 ~ 56*	56 ~ 46*
500kHz ~ 5MHz	56	46
5MHz ~ 30MHz	60	50

Notes: 1. Emission level=Read level + LISN factor-Preamp factor + Cable loss
 2 * Decreasing linearly with logarithm of frequency.
 3. The lower limit shall apply at the transition frequencies.

3.5 EUT Configuration on Test

The following equipments are installed on Conducted Emission Test to meet EN 61326-1 requirement and operating in a manner which tends to maximize its emission characteristics in a normal application.

3.5.1 Support Equipment :

As Tested Supporting System Detail, In Section 2.2.

3.6 Operating Condition of EUT

3.6.1 Setup the EUT and simulator as shown as Section 3.2.

3.6.2 Turn on the power of all equipment.

3.6.3 Let EUT work in test modes and measure it.

3.7 Test Procedure

The EUT was placed on a non-metallic table, 80cm above the ground plane. The EUT Power connected to the power mains through a line impedance stabilization network (L.I.S.N. 1#). This provided a 50-ohm coupling impedance for the EUT (Please refer to the block diagram of the test setup and photographs). The other peripheral devices power cord connected to the power mains through a line impedance stabilization network (L.I.S.N.#2). Both sides of power line were checked for maximum conducted interference. In order to find the maximum emission, the relative positions of equipments and all of the interface cables were changed according to EN 61326-1 on conducted Disturbance test.

The bandwidth of test receiver (R & S ESHS20) is set at 10kHz. The frequency range from 150kHz to 30MHz is checked. The test results are reported and test results for Conducted Disturbance Test on Section 3.8.

3.8 Conducted Disturbance At Mains Terminals Test Results

EUT Supply By DC Power, So It Not Applicable.

4 RADIATED DISTURBANCE TEST

4.1 Test Equipments

4.1.1 For Frequency Range 30MHz~1000 MHz (At Semi Anechoic Chamber)

Equipment	Manufacturer	Model No.	Serial No.	Last Cal.	Next Cal.
EMI Test Receiver	Rohde&Schwarz	ESCI	101156	Apr. 27,15	Apr. 27,16
Bilog Antenna	ETS-LINDGREN	3142D	00135452	Apr. 27,15	Apr. 27,16
Spectrum Analyzer	Agilent	8593E	3911A04271	Apr. 27,15	Apr. 27,16
3m Semi-anechoic Chamber	ETS-LINDGREN	966	KW01	Apr. 27,15	Apr. 27,16
Signal Amplifier	SONOMA	310	187303	Apr. 27,15	Apr. 27,16
RF Cable	IMRO	IMRO-400	966 Cable 1#	Apr. 27,15	Apr. 27,16
MULTI-DEVICE Controller	ETS-LINDGREN	2090	126913	N/A	N/A
Antenna Holder	ETS-LINDGREN	2070B	00109601	N/A	N/A

4.1.2 For Frequency Range 1GHz~6 GHz (At Semi Anechoic Chamber)

Equipment	Manufacturer	Model No.	Serial No.	Last Cal.	Next Cal.
EMI Test Receiver	Rohde&Schwarz	ESCI	101156	Apr. 27,15	Apr. 27,16
Horn Antenna	DAZE	ZN30701	11003	Apr. 27,15	Apr. 27,16
Spectrum Analyzer	Agilent	8593E	3911A04271	Apr. 27,15	Apr. 27,16
3m Semi-anechoic Chamber	ETS-LINDGREN	966	KW01	Apr. 27,15	Apr. 27,16
Signal Amplifier	DAZE	ZN3380C	11001	Apr. 27,15	Apr. 27,16
RF Cable	IMRO	IMRO-400	966 Cable 1#	Apr. 27,15	Apr. 27,16
MULTI-DEVICE Controller	ETS-LINDGREN	2090	126913	N/A	N/A
Antenna Holder	ETS-LINDGREN	2070B	00109601	N/A	N/A

4.2 Block Diagram Of Test Setup

4.2.1 In Semi Anechoic Chamber (3m) Test Setup Diagram For 30MHz~1000MHz

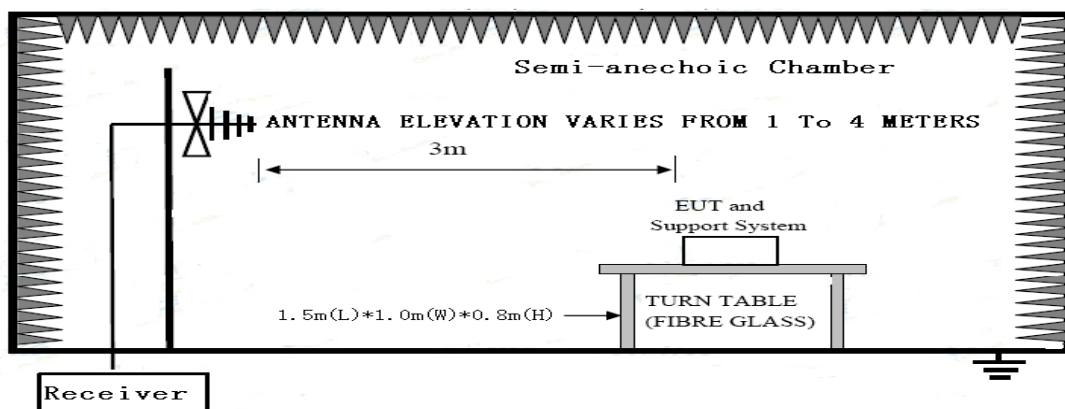

4.2.2 In Semi Anechoic Chamber (3m) Test Setup Diagram for 1-6GHz

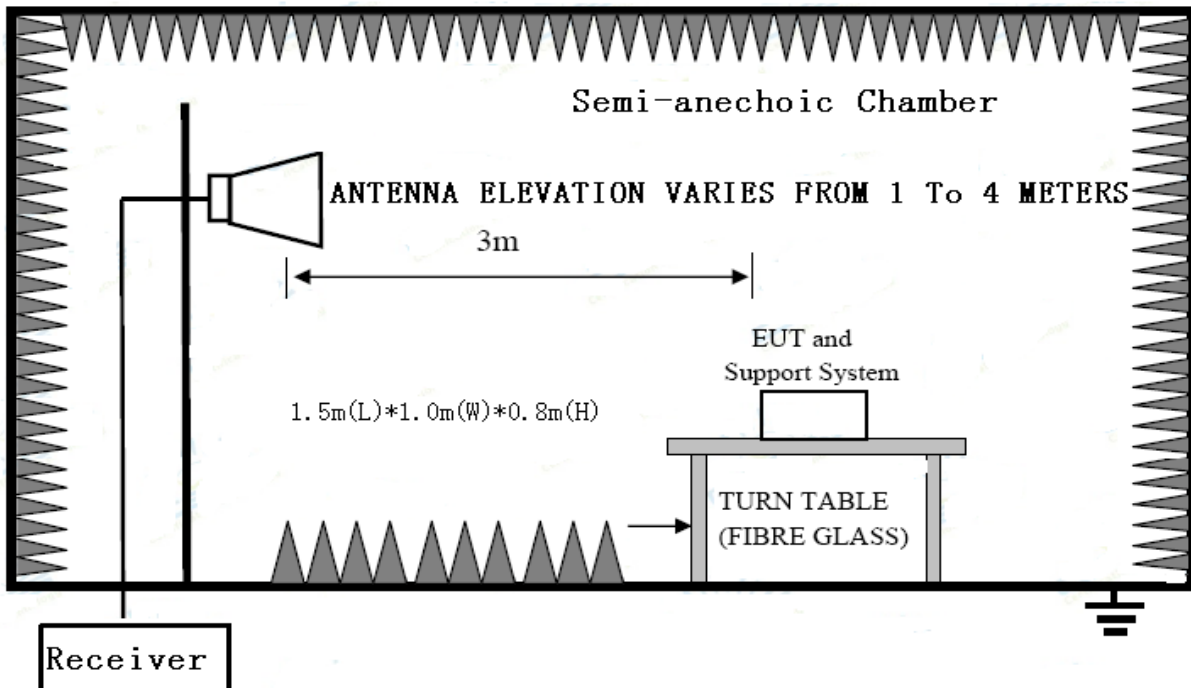

4.3 Test Standard

EN 61326-1: 2013

4.4 Radiated Disturbance Limit

All emanations from a Class B computing devices or system, including any network of conductors and apparatus connected thereto, shall not exceed the level of field strengths specified below:

FREQUENCY (MHZ)	DISTANCE (Meters)	FIELD STRENGTHS LIMITS (dB μ V/m)
30 ~ 230	3	40
230 ~ 1000	3	70
1000~3000	3	70(Peak) 50(Average)
3000~6000	3	74(Peak) 54(Average)

- Note: (1) Emission level = Read level +Antenna Factor-Preamp Factor +Cable Loss
 (2) The lower limit shall apply at the transition frequencies.
 (3) Distance refers to the distance in meters between the test instrument antenna and the closed point of any part of the E.U.T.

4.5 EUT Configuration on Test

The EN 61326-1 Class B regulations test method must be used to find the maximum emission during Radiated Disturbance test. The configuration of EUT is same as used in Conducted Disturbance test. Please refer to Section 3.5.

4.6 Operating Condition of EUT

4.6.1 Setup the EUT and simulator as shown as Section 4.2.

4.6.2 Turned on the power of all equipment

4.6.3 Let EUT work in test modes and measure it.

4.7 Test Procedure

The EUT was placed on a non-metallic table, 80 cm above the ground plane inside a semi-anechoic chamber. An antenna was located 3m & 3m from the EUT on an adjustable mast. A pre-scan was first performed in order to find prominent radiated emissions. For final emissions measurements at each frequency of interest, the EUT were rotated and the antenna height was varied between 1m and 4m in order to maximize the emission. Measurements in both horizontal and vertical polarities were made and the data was recorded. In order to find the maximum emission, the relative positions of equipments and all the interface cables were changed according to EN 61326-1 on Radiated Disturbance test.

The bandwidth setting on the test receiver (ROHDE&SCHWARZ TEST RECEIVER ESCI) is 120 kHz.

The resolution bandwidth of the Agilent Spectrum Analyzer 8593E was set at 1MHz. (For above 1GHz)

The frequency range from 30MHz to 1000MHz was pre-scanned with a peak detector and all final readings of measurement from Test Receiver are Quasi-Peak values.

The frequency range from 1GHz to 6GHz was checked with peak and average detector, measurement distance is 3m in 3m chamber.

Finally, selected operating situations at Semi Anechoic Chamber measurement, all the test results are listed in section 4.8.

4.8 Radiated Disturbance Test Results

PASS.

(All emissions not reported below are too low against the prescribed limits.) The EUT with the following test mode was tested and read QP values, the test results are listed in next pages.

Temperature: 24.4°C Humidity: 54%

The details of test mode is as follows:

No.	Test Mode
1.	On

FOR FREQUENCY RANGE 1GHz~6GHz

The highest frequency of the internal sources of the EUT is less than 108 MHz, the measurement shall only be made up to 1 GHz. So the frequency rang 1GHz-6GHz radiation test not applicable.

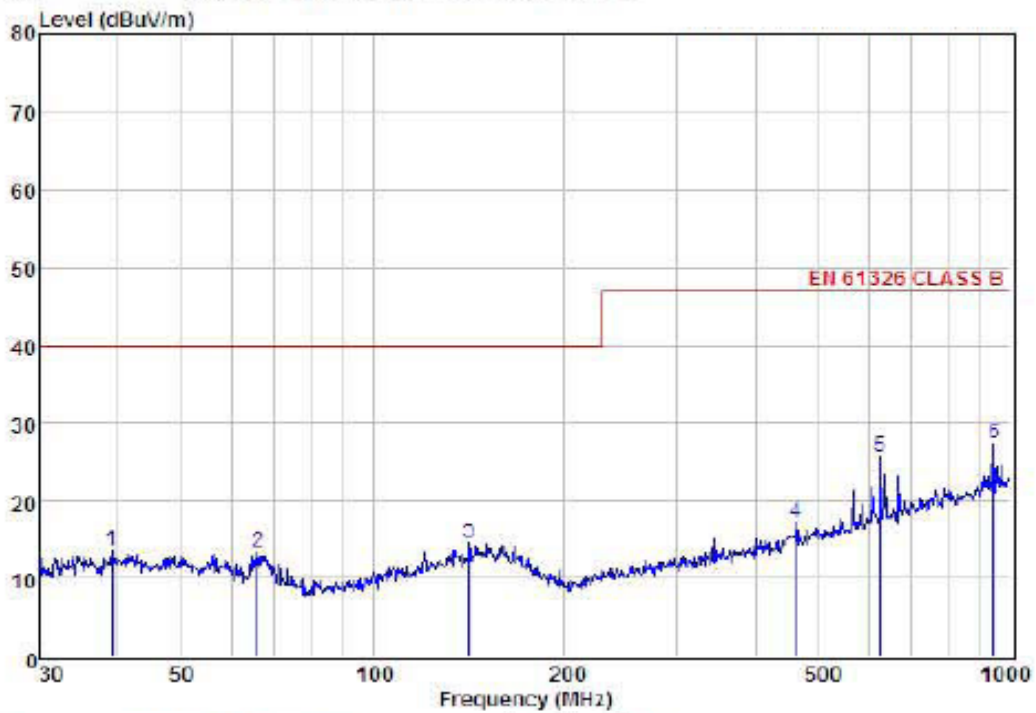

Condition : EN 61326 CLASS B Em POL: HORIZONTAL
 EUI : DIGITAL TACHOMETER
 Model No : MS6209B
 Test Mode : ON
 Power : DC 6V From Battery
 Test Engineer : Eric
 Remark :
 Temp : 24.2°C
 Hum : 54%

Item	Freq MHz	Read Level dBuV	Antenna Factor dB	Preamp Factor dB	Cable Loss dB	Level dBuV	Limit dBuV	Margin dBuV	Remark
1	39.02	26.83	14.07	27.81	0.13	13.22	40.00	-26.78	QP
2	66.03	29.41	11.59	27.20	0.26	13.06	40.00	-26.94	QP
3	141.83	27.39	13.64	26.90	0.21	14.34	40.00	-25.66	QP
4	462.35	27.63	16.08	27.52	0.98	17.17	47.00	-29.83	QP
5	625.08	33.35	19.80	27.82	1.11	25.44	47.00	-21.56	QP
6	942.13	31.54	22.09	27.62	1.19	27.20	47.00	-19.80	QP

Remark: Level = Read Level + Antenna Factor - Preamp Factor + Cable Loss

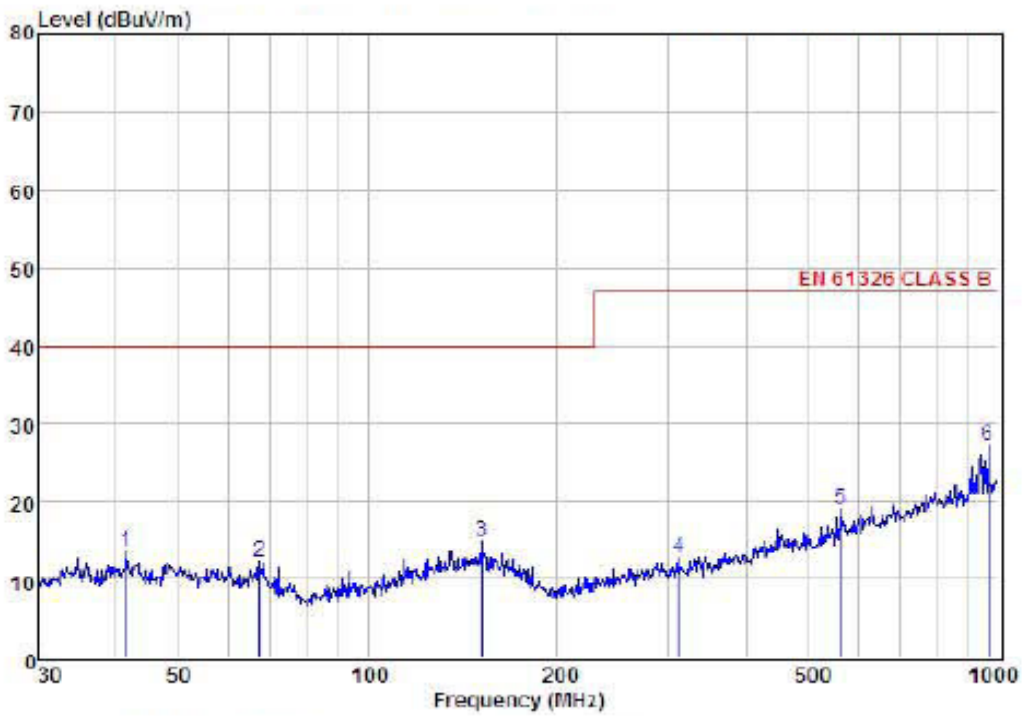

Condition : EN 61326 CLASS B Em POL: VERTICAL
 EUI : DIGITAL TACHOMETER
 Model No : MS6208B
 Test Mode : ON
 Power : DC 6V From Battery
 Test Engineer : Eric
 Remark :
 Temp : 24.2°C
 Hum : 54%

Item	Freq MHz	Read Level dBuV	Antenna Factor dB	Preamplifier Factor dB	Cable Loss dB	Level dBuV	Limit dBuV	Margin dBuV	Remark
1	41.28	27.11	13.93	27.81	0.19	13.42	40.00	-26.58	QP
2	67.44	27.65	11.21	26.98	0.29	12.17	40.00	-27.83	QP
3	152.13	27.08	14.16	26.91	0.41	14.74	40.00	-25.26	QP
4	312.18	26.05	13.14	27.21	0.58	12.56	47.00	-34.44	QP
5	562.66	27.56	17.60	27.73	1.34	18.77	47.00	-28.23	QP
6	965.54	30.42	22.19	27.60	1.97	26.98	47.00	-20.02	QP

Remark: Level = Read Level + Antenna Factor - Preamp Factor + Cable Loss

5 HARMONIC CURRENT TEST

5.1 Test Equipments

Equipment	Manufacturer	Model No.	Serial No.	Last Cal.	Next Cal.
5kVA AC Power Source	California Instruments	5001iX-CTS-400	60138	Apr. 27,15	Apr. 27,16
Harmonic/Flicker Test System	California Instruments	PACS-1	72847	Apr. 27,15	Apr. 27,16

5.2 Block Diagram of Test Setup

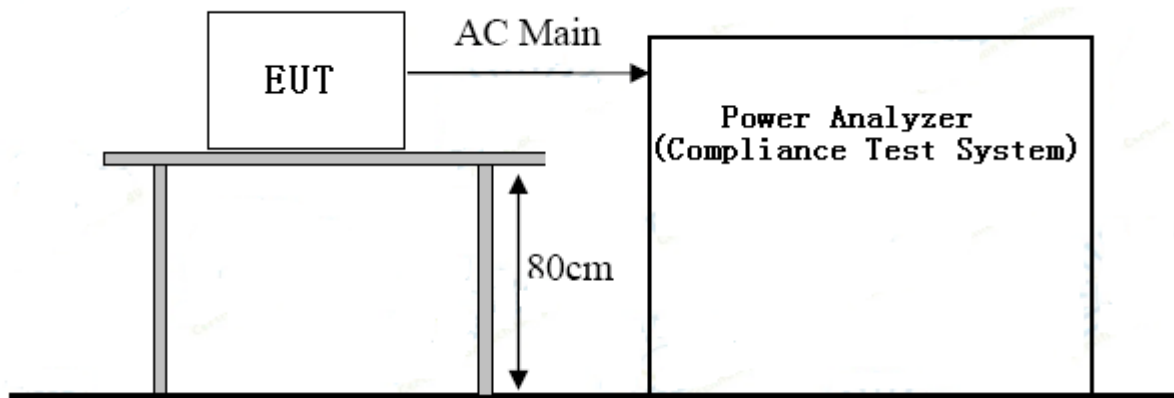

5.3 Test Standard

EN 61000-3-2: 2014; Class A

5.4 Limits of Harmonic Current

LIMITS FOR CLASS D EQUIPMENT		
HARMONIC ORDER (N)	MAXIMUM PERMISSIBLE HARMONIC CURRENT PER WATT (MA/W)	MAXIMUM PERMISSIBLE HARMONIC CURRENT (A)
3	3.4	0.23
5	1.9	1.14
7	1.0	0.77
9	0.5	0.40
11	0.35	0.33
13	0.30	0.21
15 ≤ n ≤ 39 (odd harmonic only)	3.85/n	0.15 × 15/n

LIMITS FOR CLASS A EQUIPMENT	
HARMONIC ORDER N	MAXIMUM PERMISSIBLE HARMONIC CURRENT A
Odd harmonics	
3	2,30
5	1,14
7	0,77
9	0,40
11	0,33
13	0,21
$15 \leq n \leq 39$	0,15 15/n
Even harmonics	
2	1,08
4	0,43
6	0,30
$8 \leq n \leq 40$	0,23 8/n

LIMITS FOR CLASS A EQUIPMENT	
HARMONIC ORDER N	MAXIMUM PERMISSIBLE HARMONIC CURRENT EXPRESSED AS A PERCENTAGE OF THE INPUT CURRENT AT THE FUNDAMENTAL FREQUENCY % A
2	2
3	$30 \cdot \lambda^*$
5	10
7	7
9	5
$11 \leq n \leq 39$	3
(odd harmonics only)	
* λ is the circuit power factor	

5.5 Operating Condition of EUT

Same as Section 3.6. except the test setup replaced by Section 5.2.

5.6 Test Procedure

The EUT was placed on the top of a wooden table 0.8 meters above the ground and operated to produce the maximum harmonic components under normal operating conditions for each successive harmonic component in turn. The correspondent test program of test instrument to measure the current harmonics emanated from EUT is chosen. The measure time shall be not less than the necessary for the EUT to be exercised

5.7 Test Results

EUT Supply by DC Power, So it not applicable.

6 VOLTAGE FLUCTUATIONS & FLICKER TEST

6.1 Test Equipment

Same as Section 5.1.

6.2 Block Diagram of Test Setup

Same as Section 5.2

6.3 Test Standard

EN 61000-3-3: 2013

6.4 Limits of Voltage Fluctuation and Flick

TEST ITEM	LIMIT	NOTE
Pst	1.0	Pst means Short-term flicker indicator
P1t	0.65	P1t means long-term flicker indicator
P1t	0.2	Tdt means maximum time that dt exceeds 3%
dmax (%)	4%	dmax means maximum relative voltage change.
dc(%)	3%	dc means relative steady-state voltage change.

6.5 Operating Condition of EUT

Same as Section 5.5.

6.6 Test Procedure

The EUT was placed on the top of a wooden table 0.8 meters above the ground and operated to produce the most unfavorable sequence of voltage changes under normal conditions. During the flicker measurement, the measure time shall include that part of whole operation changes. The observation period for short-term flicker indicator is 10 minutes and the observation period for long-term flicker indicator is 2 hours.

6.7 Test Results

EUT Supply by DC Power, So it not applicable.

7 IMMUNITY PERFORMANCE CRITERIA

Performance Level

The test results shall be classified in terms of the loss of function or degradation of performance of the equipment under test, relative to a performance level by its manufacturer or the requestor of the test, or the agreed between the manufacturer and the purchaser of the product.

Definition related to the performance level:

1. Based on the used product standard
2. Based on the declaration of the manufacturer, requestor or purchaser

Performance criterion A

When seen from the normal viewing distance, the EUT shall operate with no change beyond the manufacturer's specification, in flicker, colour, focus and jitter (except for the power frequency magnetic field test).

Power frequency magnetic field test

For CRT monitors, the following also applies: The jitter shall be measured using a measuring microscope as specified in 6.6.14 of ISO 9241-3.

$$\frac{(\text{Character height in mm} + 0.3) \times 2.5}{33.3}$$

The jitter (in mm) shall not exceed the value $\frac{(\text{Character height in mm} + 0.3) \times 2.5}{33.3}$ when the CRT monitor is immersed in a continuous magnetic field of 1A/m (r.m.s.) at one of the power frequencies of 50Hz.

Alternatively, a field of 50A/m may be applied, and a transparent graduated mask used to assess the jitter. In that case, the jitter shall not exceed 50 times the value in the above formula.

NOTE-This test level is used to simplify the measurement of jitter. Lesser values of the test level may be used if non-linearity is experienced, due to, for example, saturation of screening material.

The EUT shall be tested in two positions, both perpendicular to the magnetic field.

Performance criterion B

Screen disturbances during the application of the test are permissible.

Performance criterion C

Failures which are not self-recovered after removal of the external disturbance, but which can be recovered to normal operation by reset or reboot are permissible.

8 ELECTROSTATIC DISCHARGE IMMUNITY TEST

8.1 Test Equipments

Equipment	Manufacturer	Model No.	Serial No.	Last Cal.	Next Cal.
ESD Generator	TESEQ	NSG437	433	Apr. 28,15	Apr. 28,16

8.2 Block Diagram of Test Setup

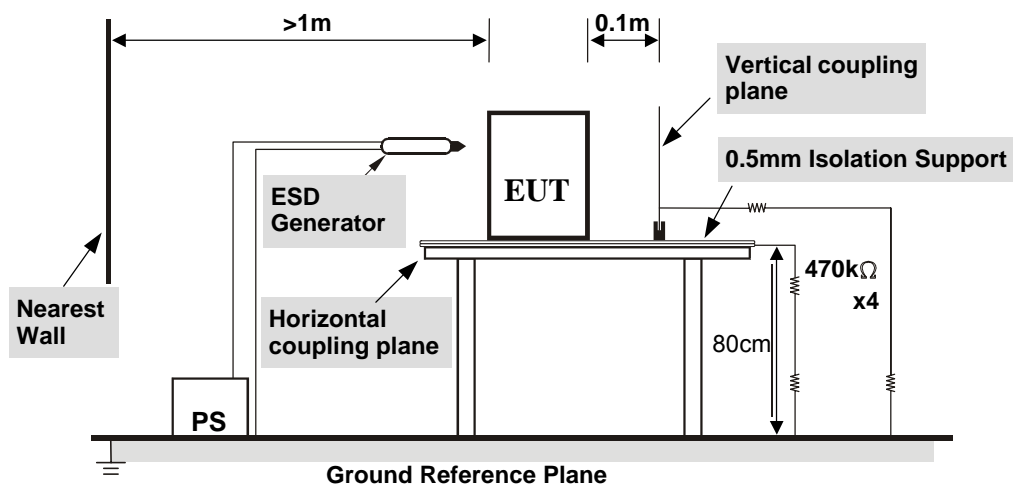

8.3 Test Standard

EN 61326-2-2: 2013(IEC 61000-4-2: 2008)
 (Severity Level 1 & 2 & 3 for Air Discharge at 2 kV & 4 kV & 8kV,
 Severity Level 1 & 2 for Contact Discharge at 2 kV & 4kV)

8.4 Severity Levels and Performance Criterion

8.4.1 Severity level

LEVEL	TEST VOLTAGE CONTACT DISCHARGE (KV)	TEST VOLTAGE AIR DISCHARGE (KV)
1	2	2
2	4	4
3	6	8
4	8	15
X	Special	Special

8.4.2 Performance criterion : B

8.5 EUT Configuration

The configurations of EUT are listed in Section 3.5.

8.6 Operating Condition of EUT

Same as Conducted Emission test that is listed in Section 3.6. except the test set up replaced by Section 8.2.

8.7 Test Procedure

8.7.1 Air Discharge:

The test was applied on non-conductive surfaces of EUT. The round discharge tip of the discharge electrode was approached as fast as possible to touch the EUT. After each discharge, the discharge electrode was removed from the EUT. The generator was re-triggered for a new single discharge and repeated 20 times for each pre-selected test point. This procedure was repeated until all the air discharge completed

8.7.2 Contact Discharge:

All the procedure was same as Section 8.7.1. except that the generator was re-triggered for a new single discharge and repeated 50 times for each pre-selected test point. The tip of the discharge electrode was touching the EUT before the discharge switch was operated.

8.7.3 Indirect discharge for horizontal coupling plane:

At least 20 single discharges were applied to the horizontal coupling plane, at points on each side of the EUT. The discharge electrode positions vertically at a distance of 0.1m from the EUT and with the discharge electrode touching the coupling plane.

8.7.4 Indirect discharge for vertical coupling plane:

At least 20 single discharges were applied to the center of one vertical edge of the coupling plane. The coupling plane, of dimensions 0.5m X 0.5m, was placed parallel to, and positioned at a distance of 0.1m from the EUT. Discharges were applied to the coupling plane, with this plane in sufficient different positions that the four faces of the EUT are completely illuminated.

8.8 Test Results

PASS.

The EUT was tested and all the test results are listed in next page.

Electrostatic Discharge Test Results

Applicant	: Shenzhen New Huayi Instrument Co., Ltd	Test Date	: March 15, 2016
EUT	: DIGITAL TACHOMETER	Temperature	: 24°C
M/N	: MS6208B	Humidity	: 56%
Test Voltage	: DC 6V From Battery	Test Mode	: ON
Test Engineer	: Andy	Pressure	: 100.6KPa
Required Performance	: B	Actual Performance	: B

Air Discharge: $\pm 2\text{kV}$ $\pm 4\text{kV}$ $\pm 8\text{kV}$ # For Air Discharge each Point Positive 10 times and negative 10 times discharge.
 Contact Discharge: $\pm 2\text{kV}$ $\pm 4\text{kV}$ # For Contact Discharge each point positive 10 times and negative 10 times discharge
 For the time interval between successive single discharges an initial value of one second.

Discharge Voltage (kV)	Type of discharge	Dischargeable Points	Performance		Result (Pass/Fail)
			Required	Observation	
± 2	Air	1, 2, 3	B	B	Pass
± 4	Air	1, 2, 3	B	B	Pass
± 8	Air	1, 2, 3	B	B	Pass
± 2	HCP-Bottom	Edge of the HCP	B	B	Pass
± 2	VCP-Front	Center of the VCP	B	B	Pass
± 2	VCP-Left	Center of the VCP	B	B	Pass
± 2	VCP-Back	Center of the VCP	B	B	Pass
± 2	VCP-Right	Center of the VCP	B	B	Pass
± 4	HCP-Bottom	Edge of the HCP	B	B	Pass
± 4	VCP-Front	Center of the VCP	B	B	Pass
± 4	VCP-Left	Center of the VCP	B	B	Pass
± 4	VCP-Back	Center of the VCP	B	B	Pass
± 4	VCP-Right	Center of the VCP	B	B	Pass

Discharge Points Description			
1	Slots	5	
2	Button	6	
3	LED Screen	7	
4		8	
Test Equipment: ESD Tester (NSG437)			
Remark:			

Discharge was considered on Contact and Air and Horizontal Coupling Plane (HCP) and Vertical Coupling Plane (VCP).

9 RF FIELD STRENGTH SUSCEPTIBILITY TEST

9.1 Test Equipments

Equipment	Manufacturer	Model No.	Serial No.	Last Cal.	Next Cal.
BiConiLog Antenna	ETS	3142C	00060445	Nov.28,15	Nov.28,16
Amplifier	BONN ELEKTRONIK	BLWA0840-50/30D	066454B	Nov.28,15	Nov.28,16
Amplifier	BONN ELEKTRONIK	BLWA0840-50/100D	066454A	Nov.28,15	Nov.28,16
Signal Generator	Rohde&Schwarz	SML03	102947	Nov.28,15	Nov.28,16
Signal Generator	Rohde&Schwarz	SMB100A	1406600K02-104532-DF	Nov.28,15	Nov.28,16
Power Meter	Rohde&Schwarz	NRVD	102051	Nov.28,15	Nov.28,16

9.2 Block Diagram of Test Setup

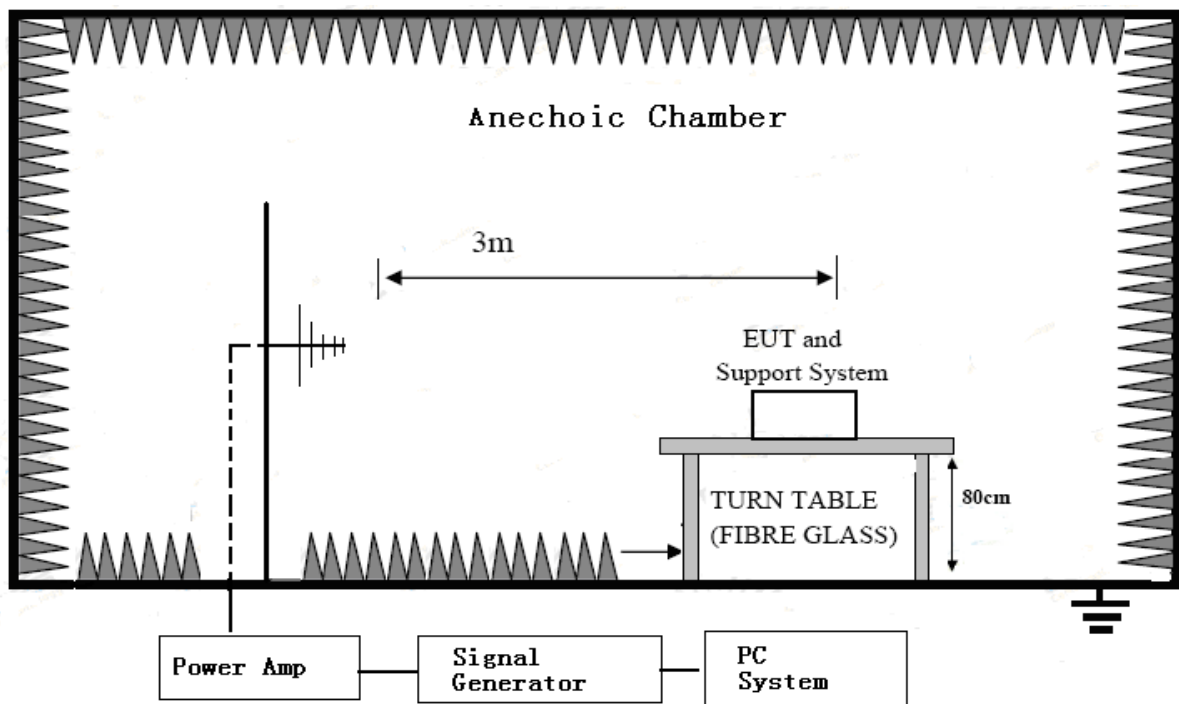

9.3 Test Standard

EN 61326-2-2: 2013 (IEC 61000-4-3:2006+A1:2007+A2:2010)
(Severity Level: 2 at 3V / m)

9.4 Severity Levels and Performance Criterion

9.4.1 Limit

Frequency	Range
80 MHz to 1 GHz	10 V/m
1,4 GHz to 2 GHz	3 V/m
2,0 GHz to 2,7 GHz	1 V/m

9.4.2 Severity level

Level	Test Field Strength V/m
1	1
2	3
3	10
X	Special

9.4.3 Performance criterion : A

9.5 EUT Configuration

The configurations of EUT are listed in Section 3.5.

9.6 Operating Condition of EUT

Same as Conducted Emission test that is listed in Section 3.6. except the test set up replaced by Section 9.2.

9.7 Test Procedure

Testing was performed in a Fully anechoic chamber as recommended by IEC 61000-4-3. The EUT was placed on an 80 cm high non-conductive table located in the area of field uniformity. The radiating antenna was placed 3m in front of the EUT and Support system, and dwell time of the radiated interference was controlled by an automated, computer-controlled system. The signal source was stepped through the applicable frequency range at a rate no faster than 1% of the fundamental. The signal was amplitude modulated 80% over the frequency range 80 MHz to 1GHz at a level of 10 V/m, frequency range 1.4 GHz to 2GHz at a level of 3 V/m, frequency range 2 GHz to 2.7GHz at a level of 1 V/m. The dwell time was set at 3 s. Field presence was monitored during testing via a field probe placed in close proximity to the EUT. Throughout testing, the EUT was closely monitored for signs of susceptibility. The test was performed with the antennae oriented in both a horizontal and vertical polarization.

All the scanning conditions are as follows:

Condition of Test	Remarks
1. Test Fielded Strength	10 V/m ,3 V/m, 1 V/m
2. Radiated Signal	80% amplitude modulated with a 1kHz sine wave
3. Scanning Frequency	80 - 2700 MHz
4. Sweeping time of radiated	0.0015 decade/s
5. Dwell Time	3 Sec.

9.8 Test Results

PASS.

The EUT was tested and all the test results are listed in next page.

RF Field Strength Susceptibility Test Results

Applicant	: Shenzhen New Huayi Instrument Co., Ltd	Test Date	: March 15, 2016		
EUT	: DIGITAL TACHOMETER	Temperature	: 24°C		
M/N	: MS6208B	Humidity	: 56%		
Test Voltage	: DC 6V From Battery	Test Mode	: ON		
Test Engineer	: Andy	Pressure	: 100.6KPa		
Frequency Range	: 80 MHz -1000MHz	Field Strength	: 10V/m		
Required Performance	: A	Actual Performance	: A		
Modulation: <input checked="" type="checkbox"/> AM <input type="checkbox"/> Pulse <input type="checkbox"/> none 1 kHz 80%					
		Frequency Rang :80 MHz -1000MHz			
Steps	1%				
	Horizontal		Vertical	Result	
	Required	Observation	Required	Observation	(Pass / Fail)
Front	A	A	A	A	PASS
Right	A	A	A	A	PASS
Rear	A	A	A	A	PASS
Left	A	A	A	A	PASS
Test Equipment : 1. Signal Generator : Rohde&Schwarz SML03 2. Power Amplifier : BONN ELEKTRONIK BLWA0840-50/30D 3. Power Antenna : BONN ELEKTRONIK BLWA0840-50/30D 4. Power Meter : Rohde&Schwarz NRVD					
Remark: No function loss					

RF Field Strength Susceptibility Test Results

Applicant	: Shenzhen New Huayi Instrument Co., Ltd	Test Date	: March 15, 2016		
EUT	: DIGITAL TACHOMETER	Temperature	: 24°C		
M/N	: MS6208B	Humidity	: 56%		
Test Voltage	: DC 6V From Battery	Test Mode	: ON		
Test Engineer	: Andy	Pressure	: 100.6KPa		
Frequency Range	: 1400 MHz -2000MHz	Field Strength	: 3V/m		
Required Performance	: A	Actual Performance	: A		
Modulation: <input checked="" type="checkbox"/> AM <input type="checkbox"/> Pulse <input type="checkbox"/> none 1 kHz 80%					
		Frequency Rang : 1400 MHz -2000MHz			
Steps	1%				
	Horizontal		Vertical		Result
	Required	Observation	Required	Observation	(Pass / Fail)
Front	A	A	A	A	PASS
Right	A	A	A	A	PASS
Rear	A	A	A	A	PASS
Left	A	A	A	A	PASS
Test Equipment : 1. Signal Generator : Rohde&Schwarz SML03 2. Power Amplifier : BONN ELEKTRONIK BLWA0840-50/30D 3. Power Antenna : BONN ELEKTRONIK BLWA0840-50/30D 4. Power Meter : Rohde&Schwarz NRVD					
Remark: No function loss					

RF Field Strength Susceptibility Test Results

Applicant	: Shenzhen New Huayi Instrument Co., Ltd	Test Date	: March 15, 2016		
EUT	: DIGITAL TACHOMETER	Temperature	: 24°C		
M/N	: MS6208B	Humidity	: 56%		
Test Voltage	: DC 6V From Battery	Test Mode	: ON		
Test Engineer	: Andy	Pressure	: 100.6KPa		
Frequency Range	: 2000 MHz -2700MHz	Field Strength	: 1V/m		
Required Performance	: A	Actual Performance	: A		
Modulation: <input checked="" type="checkbox"/> AM <input type="checkbox"/> Pulse <input type="checkbox"/> none 1 kHz 80%					
		Frequency Rang : 2000 MHz -2700MHz			
Steps	1%				
	Horizontal		Vertical		Result
	Required	Observation	Required	Observation	(Pass / Fail)
Front	A	A	A	A	PASS
Right	A	A	A	A	PASS
Rear	A	A	A	A	PASS
Left	A	A	A	A	PASS
Test Equipment : 1. Signal Generator : Rohde&Schwarz SML03 2. Power Amplifier : BONN ELEKTRONIK BLWA0840-50/30D 3. Power Antenna : BONN ELEKTRONIK BLWA0840-50/30D 4. Power Meter : Rohde&Schwarz NRVD					
Remark: No function loss					

10 ELECTRICAL FAST TRANSIENT/BURST IMMUNITY TEST

10.1 Test Equipments

Equipment	Manufacturer	Model No.	Serial No.	Last Cal.	Next Cal.
EFT Tester	EMtest	EFT500N5	V1105108698	Apr 27,15	Apr 27,16
EFT Coupling Clamp	EMtest	HFK	0211-168	Apr 27,15	Apr 27,16

10.2 Block Diagram of Test Setup

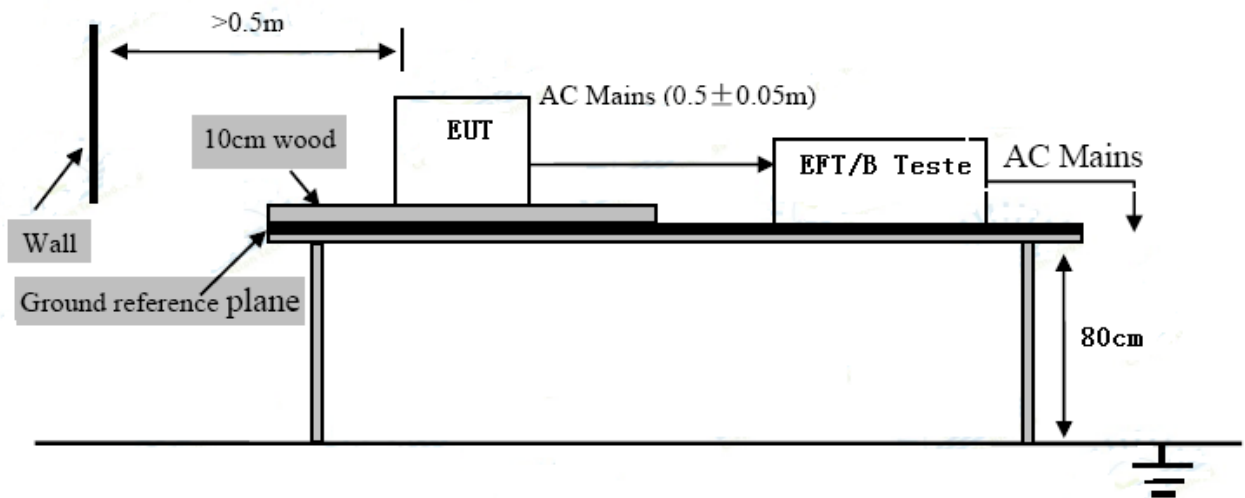

10.3 Test Standard

EN 61326-2-2: 2013 (IEC 61000-4-4:2012)
(Severity Level 2 at 1kV)

10.4 Severity Levels and Performance Criterion

10.4.1 Severity level

Open Circuit Output Test Voltage $\pm 10\%$		
LEVEL	On Power Supply Lines	On I/O (Input/Output) Signal Data And Control Lines
1	0.5 kV	0.25 kV
2	1 kV	0.5 kV
3	2 kV	1 kV
4	4 kV	2 kV
X	Special	Special

10.4.2 Performance criterion : B

10.5 EUT Configuration

The configurations of EUT are listed in Section 3.5.

10.6 Operating Condition of EUT

Same as Conducted Emission test that is listed in Section 3.6. except the test set up replaced by Section 10.2.

10.7 Test Procedure

The EUT and its simulators were placed on the ground reference plane and were insulated from it by a wood support 0.1m + 0.01m thick. The ground reference plane was 1m*1m metallic sheet with 0.65mm minimum thickness. This reference ground plane was project beyond the EUT by at least 0.1m on all sides and the minimum distance between EUT and all other conductive structure, except the ground plane was more than 0.5m. All cables to the EUT was placed on the wood support, cables not subject to EFT/B was routed as far as possible from the cable under test to minimize the coupling between the cables.

10.7.1 For input and AC power ports:

The EUT was connected to the power mains by using a coupling device that couples the EFT interference signal to AC power lines. Both positive transients and negative transients of test voltage were applied during compliance test and the duration of the test can't less than 1min.

10.7.2 For signal lines and control lines ports:

It's unnecessary to test.

10.7.3 For DC input and DC output power ports:

It's unnecessary to test.

10.8 Test Results

EUT Supply by DC Power, So it not applicable.

11 SURGE TEST

11.1 Test Equipments

Equipment	Manufacturer	Model No.	Serial No.	Last Cal.	Next Cal.
Surge Tester	EMtest	UCS500N7	V1105108699	Apr. 27,15	Apr. 27,16
EMS Multifunctional test system	SCHAFFNER	6100Series	34326	Apr. 27,15	Apr. 27,16
Transient Immunity test system	EMC-PARTNER	TRANSIENT2000	845	Apr. 27,15	Apr. 27,16

11.2 Block Diagram of Test Setup

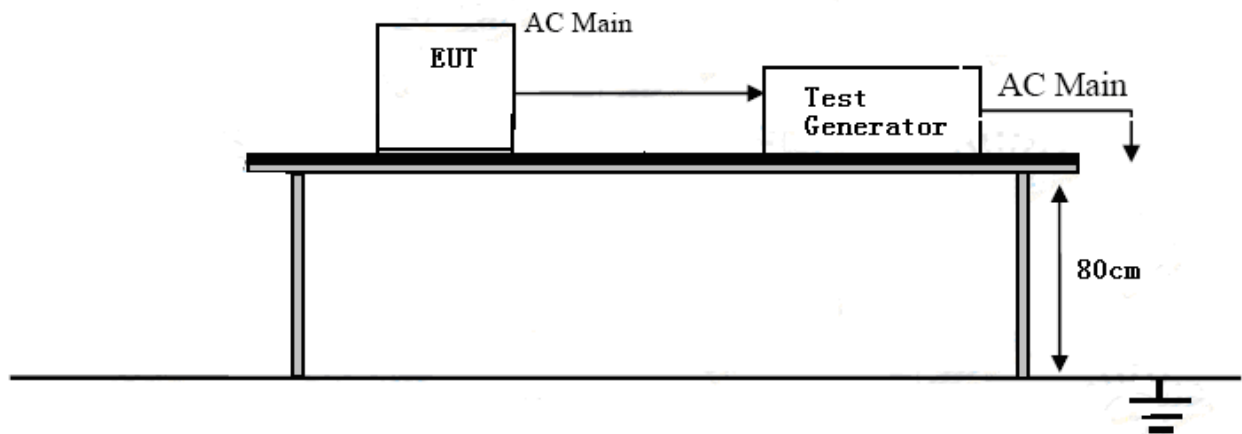

11.3 Test Standard

EN 61326-2-2: 2013 (IEC 61000-4-5: 2014)
 (Severity Level: Line to Line was Level 2 at 1kV)

11.4 Severity Levels and Performance Criterion

11.4.1 Severity level

SEVERITY LEVEL	OPEN-CIRCUIT TEST VOLTAGE KV
1	0.5
2	1.0
3	2.0
4	4.0
*	SPECIAL

11.4.2 Performance criterion: B

11.5 EUT Configuration

The configurations of EUT are listed in Section 3.5.

11.6 Operating Condition of EUT

Same as Conducted Emission test that is listed in Section 3.6. except the test set up replaced by Section 11.2

11.7 Test Procedure

- 1) Set up the EUT and test generator as shown on Section 11.2.
- 2) For line-to-line coupling mode, provide a 1kV 1.2/50us voltage surge (at open-circuit condition) and 8/20us current surge to EUT selected points, and for active line / neutral lines to ground are same except test level is 2kV.
- 3) At least 5 positive and 5 negative (polarity) tests with a maximum 1/min repetition rate are applied during test.
- 4) Different phase angles are done individually.
- 5) Record the EUT operating situation during compliance test and decide the EUT immunity criterion for above each test.

11.8 Test Results

EUT Supply by DC Power, So it not applicable.

12 INJECTED CURRENTS SUSCEPTIBILITY TEST

12.1 Test Equipments

Equipment	Manufacturer	Model No.	Serial No.	Last Cal.	Next Cal.
C/S Test System	EMtest	CIT-10	126B1164	Apr. 27,15	Apr. 27,16
CDN	Luthi	L-801 M2/M3	2789	Apr. 27,15	Apr. 27,16
Electromagnetic Injection Clamp	Luthi	EM101	36041	Apr. 28,15	Apr. 28,16

12.2 Block Diagram of Test Setup

50 Ω TERMINATOR

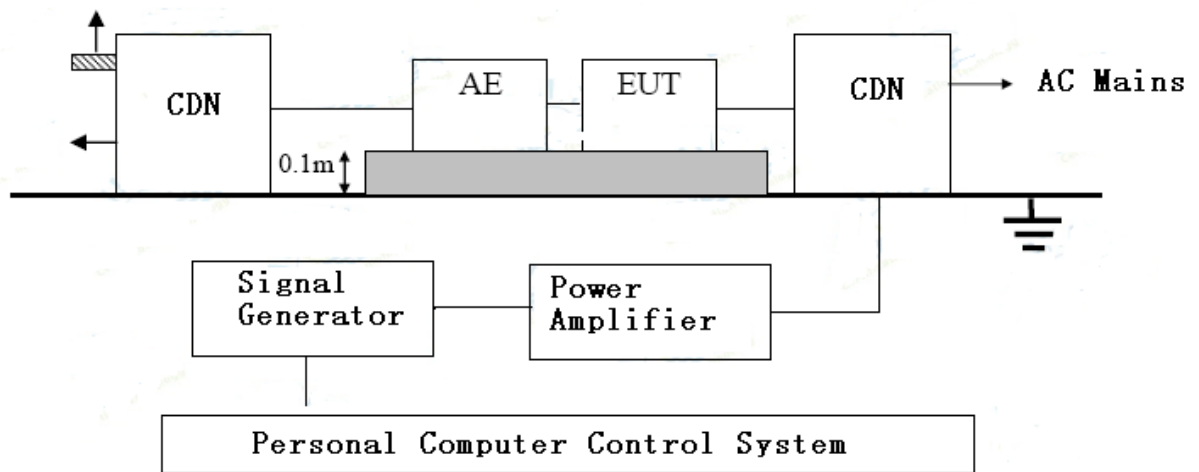

12.3 Test Standard

EN 61326-2-2: 2013 (IEC 61000-4-6: 2013) (Severity Level 2 at 3V (r.m.s.) and frequency is from 0.15MHz to 80MHz)

12.4 Severity Levels and Performance Criterion

12.4.1 Severity level

LEVEL	VOLTAGE LEVEL (E.M.F.) V
1	1
2	3
3	10
*	SPECIAL

12.4.2 Performance criterion: A

12.5 EUT Configuration

The configurations of EUT are listed in Section 3.5.

12.6 Operating Condition of EUT

Same as Conducted Emission test that is listed in Section 3.6. except the test set up replaced by Section 12.2.

12.7 Test Procedure

- 1) Set up the EUT, CDN and test generators as shown on Section 12.2.
- 2) Let the EUT work in test mode and test it.
- 3) The EUT are placed on an insulating support 0.1m high above a ground reference plane. CDN (coupling and decoupling device) is placed on the ground plane about 0.3m from EUT. Cables between CDN and EUT are as short as possible, and their height above the ground reference plane shall be between 10 and 30 mm (where possible).
- 4) The disturbance signal described below is injected to EUT through CDN.
- 5) The EUT operates within its operational mode(s) under intended climatic conditions after power on.
- 6) The frequency range is swept from 0.150MHz to 80MHz using 3V signal level, and with the disturbance signal 80% amplitude modulated with a 1kHz sine wave.
- 7) The rate of sweep shall not exceed 1.5×10^{-3} decades/s. Where the frequency is swept incrementally, the step size shall not exceed 1% of the start and thereafter 1% of the preceding frequency value.
- 8) Recording the EUT operating situation during compliance testing and decide the EUT immunity criterion.

12.8 Test Results

EUT Supply by DC Power, So it not applicable.

13 MAGNETIC FIELD IMMUNITY TEST

13.1 Test Equipments

Equipment	Manufacturer	Model No.	Serial No.	Last Cal.	Next Cal.
Magnetic Field Generator	EVERFINE	EMS61000-8K	YG100376N11080002	Apr 27,15	Apr 27,16

13.2 Block Diagram of Test Setup

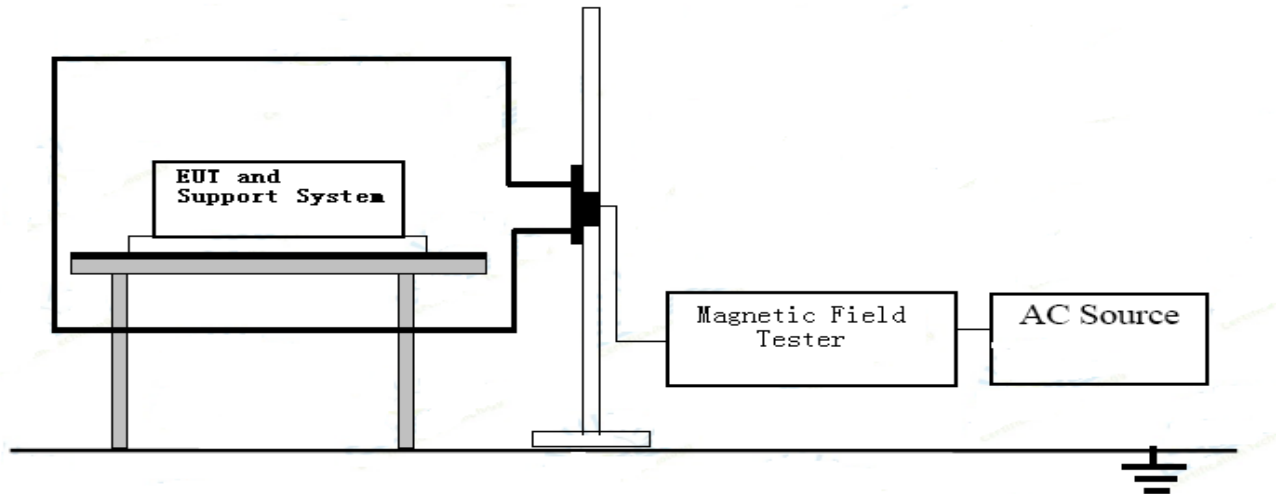

13.3 Test Standard

EN 61326-2-2: 2013 (IEC 61000-4-8: 2009)
(Severity Level 1 at 1A/m)

13.4 Severity Levels and Performance Criterion

13.4.1 Severity level

LEVEL	MAGNETIC FIELD STRENGTH A/M
1	1
2	3
3	10
4	30
5	100
X	SPECIAL

13.4.2 Performance criterion : A

13.5 EUT Configuration on Test

The configurations of EUT are listed in Section 3.5.

13.6 Operating Condition of EUT

Same as Conducted Emission test that is listed in Section 3.6. except the test set up replaced by Section 13.2.

13.7 Test Procedure

The EUT was subjected to the test magnetic field by using the induction coil of standard dimensions (1m*1m) and shown in Section 13.2. The induction coil was then rotated by 90° in order to expose the EUT to the test field with different orientations.

13.8 Test Results

The EUT not containing devices susceptible to magnetic fields, and Power-frequency magnetic field test applicable only to EUT containing devices susceptible to magnetic fields, so the test not applicable.

14 VOLTAGE DIPS AND INTERRUPTIONS TEST

14.1 Test Equipment

Equipment	Manufacturer	Model No.	Serial No.	Last Cal.	Next Cal.
Dips Tester	EVERFINE	EMS61000-11K	YG100319N1104 0005	Apr 27,15	Apr 27,16

14.2 Block Diagram of Test Setup

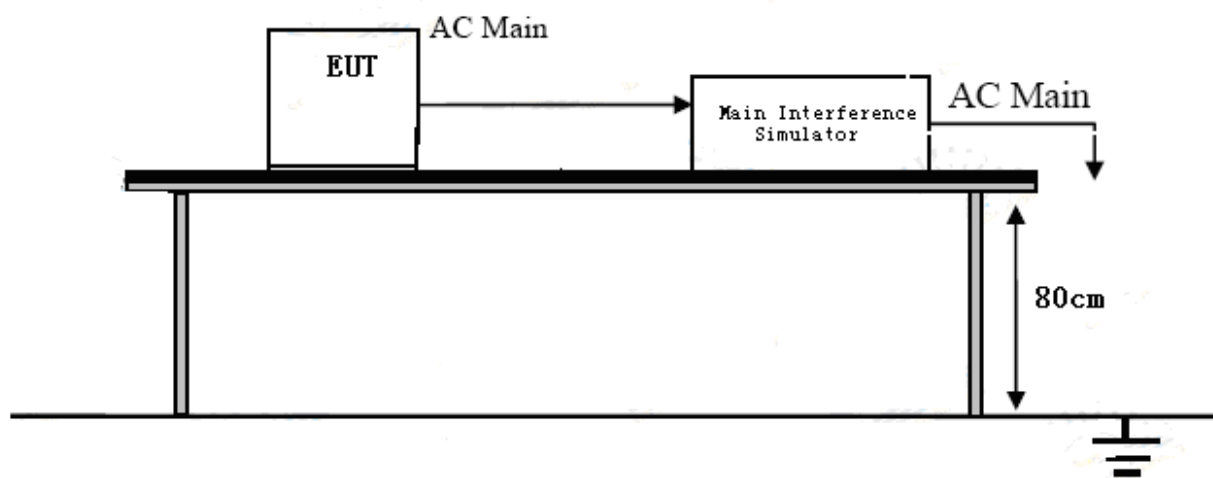

14.3 Test Standard

EN 61326-2-2: 2013(IEC 61000-4-11:2004)

14.4 Severity Levels and Performance Criterion

14.4.1 Severity level

TEST LEVEL %UT	VOLTAGE DIP AND SHORT INTERRUPTIONS% UT	PERFORMANCE CRITERION	DURATION (IN PERIOD)
0	100	C	250
0	100	B	0.5
70	30	C	25

14.4.2 Performance criterion : B & C

14.5 EUT Configuration

The configurations of EUT are listed in Section 3.5.

14.6 Operating Condition of EUT

Same as Conducted Emission test that is listed in Section 3.6. except the test set up replaced by Section 14.2.

14.7 Test Procedure

- 1) The EUT and test generator were setup as shown on Section 14.2.
- 2) The interruption is introduced at selected phase angles with specified duration.
- 3) Record any degradation of performance.

14.8 Test Results

EUT Supply by DC Power, So it not applicable.

15 PHOTOGRAPHS OF THE TEST CONFIGURATION

15.1 Photos of Radiated Emission Test (In Anechoic Chamber)

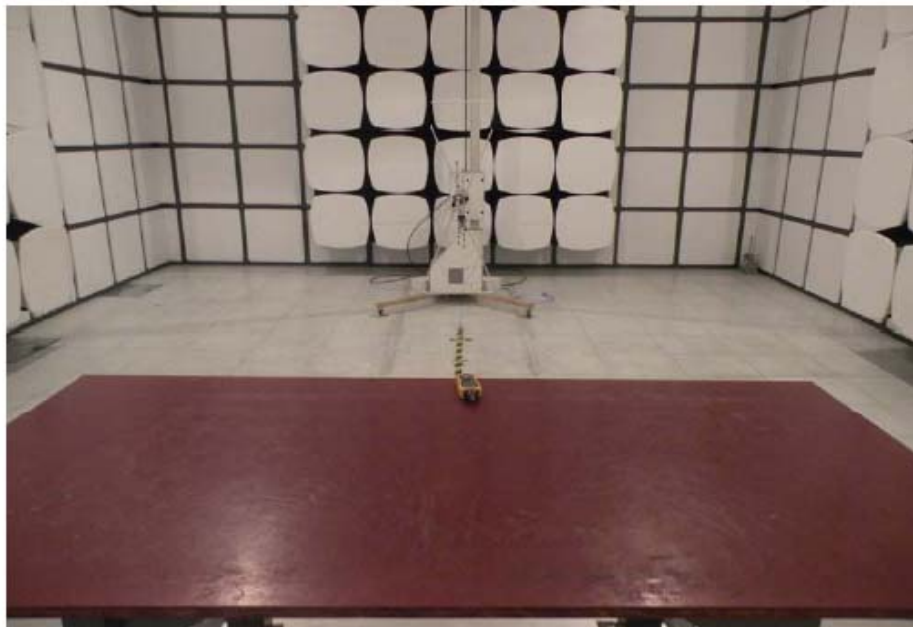
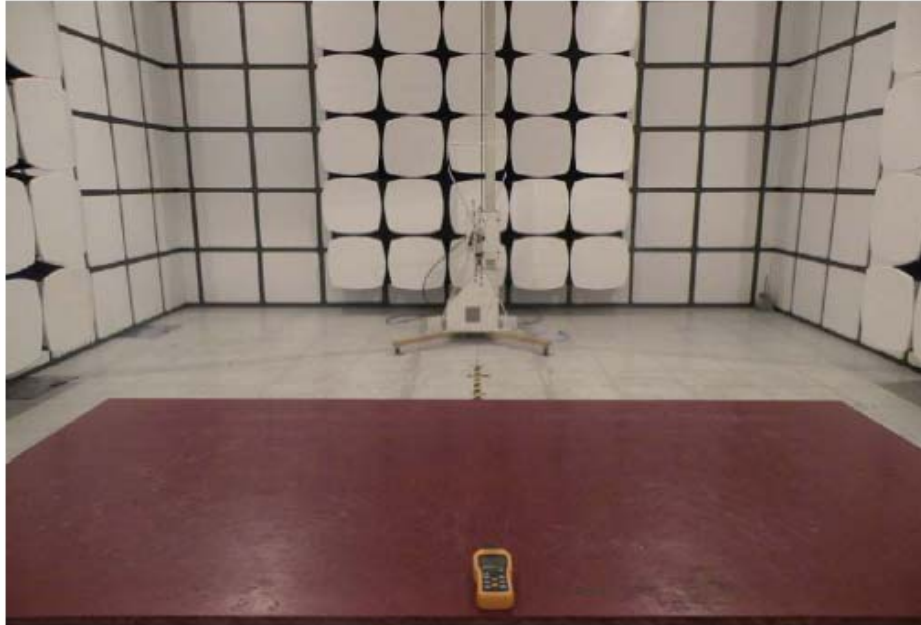

15.2 Photos of Electrostatic Discharge Immunity Test



16 PHOTOS OF THE EUT

Photo 1# Unit overview



Photo 2# Unit Overview



Photo 3# Internal View



Photo 4# Internal View



Photo 5# Internal View

