

USERS MANUAL

EARTH RESISTANCE TESTER

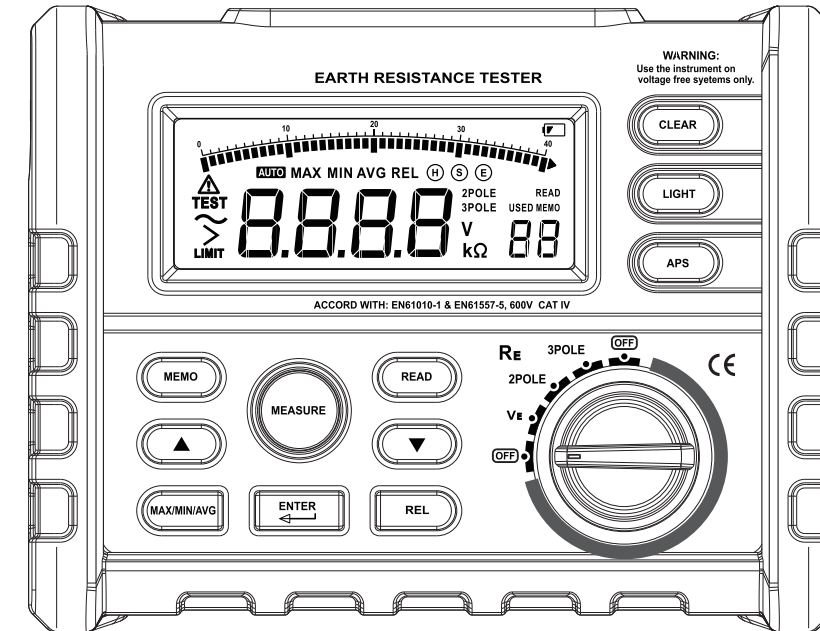

MS2302

⚠ Before using the instrument, please read this manual carefully, and save it well for future using.

EMC&LVD

Designed and Complies to
IEC61010-1
CAT.III1000V



Y01-04-0025 A0



Table of Contents

- 1. Safety.....1
- 2. Description.....4
 - 2.1 Meter Description.....4
 - 2.2 Display.....8
- 3. Specifications10
 - 3.1 Range and Precision..... 10
 - 3.2 Measurement Method.....10
 - 3.3 Using Temperature and Humidity.....10
 - 3.4 Storing Temperature and Humidity10
 - 3.5 Battery.....11
 - 3.6 Volume.....11
 - 3.7 Weight.....11

3.8 Accessories.....	11
4. Operation Instructions	12
4.1 Testing the Earth Voltage.....	12
4.2 Testing the Earth Resistance by the bi-electrode method.....	12
4.3 Testing the Earth Resistance by the tri-electrode method.....	15
4.4 Data Storage	17
4.5 Data Reading.....	18
4.6 REL Measurement.....	18
4.7 MAX/MIN/AVG Measurement.....	19
4.8 Data Deletion.....	19
4.9 Back Light.....	19
4.10 Auto Off.....	19
5. Battery Replacement	20

1. Safety

The earth resistance tester (hereinafter referred to as meter) , which is up to GB4793.1-1995 (IEC-1010-1 : 1990, the requirement on the safety of electronic measurement instruments, is designed and manufactured in accordance with IEC61016 Safety Standard, regarded as Grade II pollutant, and the maximum voltage for the meter to probe can not exceed CAT III 300V.

The users' manual includes cautions and safety regulations, which specifies the rules in usage of the meter to avoid personal injury accident and long keep the meter in good condition, therefore, please read the manual before using the meter and adhere to the operation instructions inside it, and inobservance of the manual in using the meter may cause personal injury or damage to the meter.

Safety Symbols



Danger: improper operation will cause severe or fatal injuries.



Warning: improper operation may cause severe or fatal injuries



Caution : improper operation may cause personal injuries or damage to
the meter

 **Danger**

Check if the rotating switch is set to a proper position before measurement

Never use the meter in the vicinity of explosive gases, steam or dust.

Never connect wires or probes with wet hands or when the surface of the meter is humid.

Don't touch the testing wires or probes in a measurement.

Don't open the battery cover when the meter is working.

 **Warning**

Never proceed a measurement under abnormalities, for example, the housing of the meter has been damaged so that the metal of the meter or wires are naked.

Never replace the parts of the meter by yourself or modify it. Should the meter be damaged, return it to the local dealers for examination or repair.

Don't replace the batteries when the surface of the meter is humid.

Be sure to set the switch to "OFF" and disconnect the testing wires before replacing the batteries.

**Caution**

Check if the total length of testing wires is inserted into the port before a measurement.

Take out of the batteries from the cartridge if the meter will not be used or will be stored for long.

Don't expose the meter to sunlight, high temperature, humidity or dew

Clean the meter with neutral solvents or wet cloth instead of abrasives or organic solvents

Lay the meter in store only when it is dry.

Caution:

Using this appliance in an environment with a strong radiated radio-frequency electromagnetic field (approximately 3V/m), may influence its measuring accuracy. The measuring result can be strongly deviating from the actual value.

2. Description

The meter is applicable to the testing of the earth resistance of the power supply wires, distribution wires inside a room, electrical equipment or appliance, which can be done in two measurement modes: Bi-poles or Tri-poles, and it also can be used to measure the earth voltage.

Large digital LCD and backlights applied to the meter facilitate users to read the information on LCD. Besides, the meter is capable of storing up to 100 groups of measurement data, which will not be lost even in case of power cuts so that the user can easily consult the historical data. In addition, the meter can also be used to measure maximum, minimum or average and measure relatively. Auto power-off function has been provided for it.

2.1 Meter Description

(1) Rotating Switch

It is used to selection between the measurement of earth voltage, measurement of resistance in Bi-pole method or measurement of resistance in Tri-pole method.

(2) Key of ASP

It is used to start or cease auto power-off function.

(3) Key of LIGHT

It is used to turn on or turn off the backlight.

(4) Key of CLEAR

It is used to clear away data.

(5) LCD

It is used to display the data obtained and different symbols.

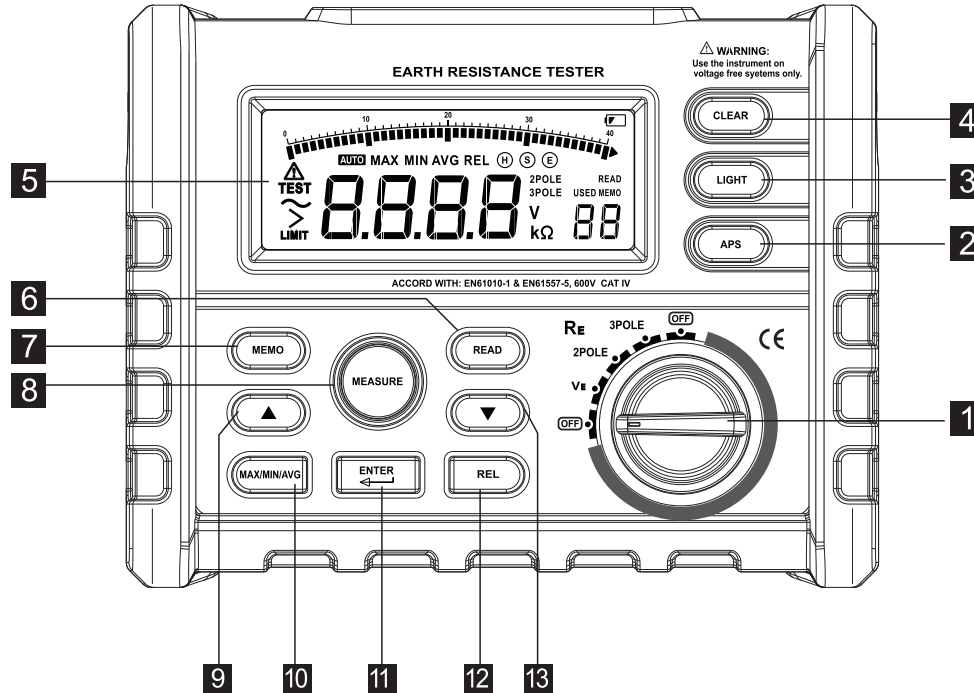

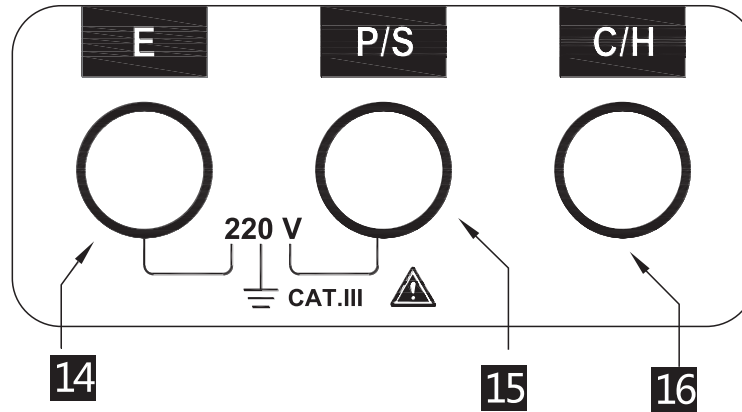

(6) Key of READ

It is used to read the data obtained.

(7) Key of MEMO

It is used to store the data obtained.

(8) Key of Measure

It is used to start or cease a measurement of resistance.

(9) Key of ▲

It is used to select a memory for storage of data obtained.

(10) Key of MAX/MIN/AVG

It is used to switch between the measurement of maximum, minimum and average.

(11) Key of ENTER

It is used to confirm a storage or reading of data.

(12) REL

It is used to select relative measurement.

(13) Key of ▼

It is used to select a memory for storage of data obtained.

(14) E socket

It is used to connect with the grounding pole.

(15) P/S socket

It is used to connect with the auxiliary grounding pole.

(16) C/H socket

It is used to connect with the auxiliary grounding pole.

2.2 LCD

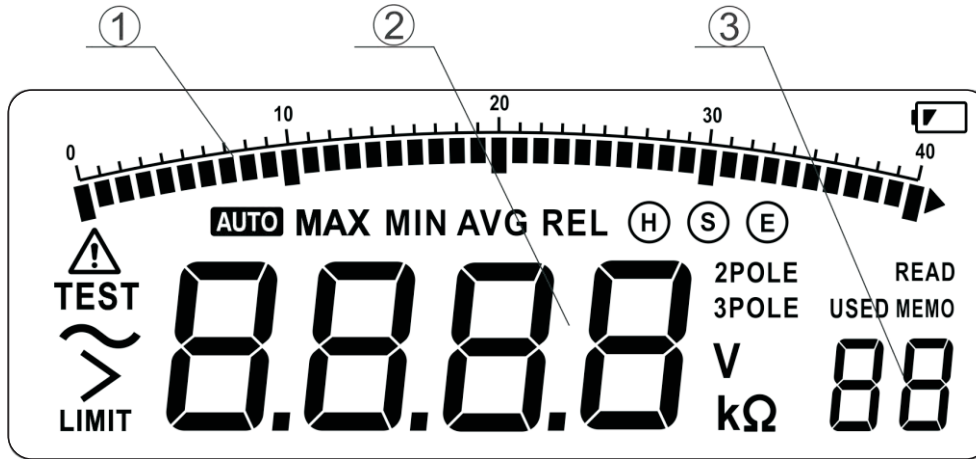





- (1) simulating bar
- (2) Display of data obtained
- (3) Display of memory used for data storage.

Descriptions of symbols on LCD:

TEST : a test is being progressed

> LIMIT : limit has been exceeded

MAX :	Maximum
MIN :	Minimum
AVG :	Average
REL :	Relative measurement
READ :	Data reading
MEMO :	Data is being put into a memory
USED :	There are data in memories.
2POLE :	Bi-pole method is being used for measurement of resistance.
3POLE :	Ti-pole method is being used for measurement of resistance.
V :	Volt(voltage)
K Ω :	Ohm(resistance)
 :	Auto power-off has been started with the symbol on
 :	Battery is low with the symbol on
 :	For socket identification
 :	AC current is used.
 :	For warnings and cautions

3. Specifications

Air temperature: $23 \pm 5^{\circ}\text{C}$ Relative humidity: <75%

3.1 Range Specifications

	Range	Precision
Earth Ground Resistance	0 ~ 29.99 Ω	$\pm(2\% \text{ rdg} + 6\text{d})$
	30.0 ~ 99.9 Ω	$\pm(3\% \text{ rdg} + 3\text{d})$
	100 ~ 999 Ω	$\pm(3\% \text{ rdg} + 3\text{d})$
	1.00k~4.00k Ω	$\pm(3\% \text{ rdg} + 3\text{d})$
Earth Voltage	0V~200V (50/60HZ)	$\pm(1\% \text{ rdg} + 5\text{d})$

3.2 Measurement method

Constant Current Conversion is used for the measurement of earth resistance, with the frequency of the testing current about 800HZ and the size about 3mA.

Average rectification is used for the measurement of earth voltage.

3.3 Temperature and humidity for measurement

0~40 $^{\circ}\text{C}$, relative humidity under 85%

3.4 Temperature and humidity for keeping the meter

-10~50 $^{\circ}\text{C}$, relative humidity under 85%

3.5 Battery

Six 1.5V AA batteries

3.6 Volume

330 X 125 X 265

3.7 Weight

3.45kg

3.8 Supplied accessories

3 test leads (one 15-meter-long red lead, one 10-meter-long green lead and one 5-meter-long black lead) , 2 auxiliary earth bars

4.Operation Instruction



In measurement of earth voltage, do not exert voltage above AC220V on the measurement port.

In measurement of earth resistance, there will occur potential of about 50 V between port E and S or between ports E and C, therefore, protect yourself from electrical shock.

Before using the meter, check the electricity in the battery by turning on the meter, checking if there is “” on display and replace the battery by following the steps described in Chapter “Replacement of the battery” if the symbol exists.

4.1 Measurement of earth voltage

Rotate the switch to ~VE position, insert the end of meter cable into sockets E and S, with another end of meter cable connected to either end of voltage source or resistance load in parallel way to measure . If there exists voltage, it will be displayed on LCD.

4.2 How to measure earth resistance by Bi-pole method

Existing earth pole, such as buried metals (metal water pipe etc) , common earth of the commercial power supply or lightning rods of high buildings, instead of auxiliary earth bars are used as auxiliary pole in this method.

(1) Test Connection Diagram

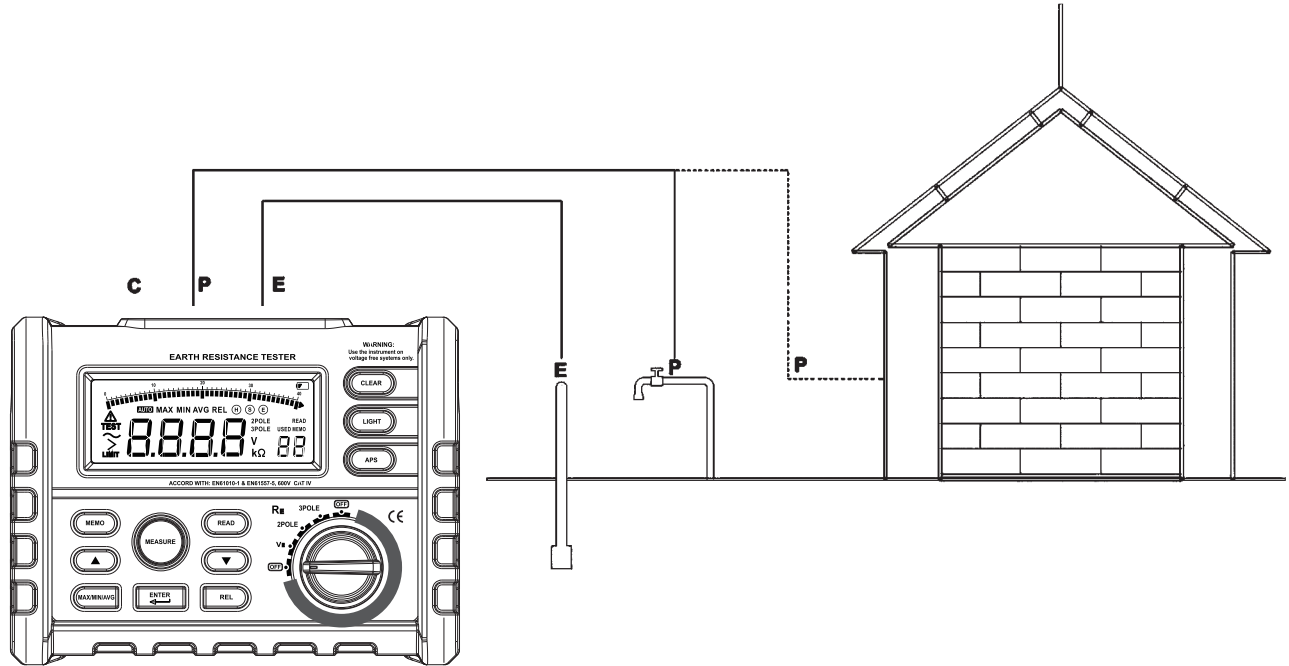

(2) Measurement of earth voltage.

Earth voltage measurement should be done before measurement of earth resistance to check the amount of earth voltage, as voltage more than 10 V is likely to cause larger error in the measurement of earth resistance. In this case, cut the measured object from the power supply and wait until the earth voltage drop for another measurement.

(3) Measurement of earth resistance

Rotate the switch to 2 POL position, press down the key of MEASURE to start the measurement, with the key LED turned on and glittering. When the measurement comes to the end automatically, the buzzer will give a sound, the key LED will go off and the data will be held automatically.

Attention: > LIMIT4000Ω displayed on LCD warns that the auxiliary earth resistance of the auxiliary earth rods is so high that the current can not flow across the meter. Check if the test leads become loose and the amount of the earth resistance of the auxiliary earth rods

(4) Value measured

R_e , value of the earth resistance measured by Bi-pole method, equals the sum of r_e , the earth resistance of earth rods, and R_X , the real earth resistance of the object measured; therefore, $R_X = R_e - r_e$, meaning that the real resistance of the object measured equals R_e minus r_e .

4.3 Measurement of the resistance by Tri-pole method

Potential Drop Method is used by the meter for the measurement of the earth resistance. Particularly, RX, the earth resistance is figured out by first allowing I, the rated current, to flow between E, the object measured (the earth rods) and C, the current pole, then measuring V, the potential difference between E and P, the voltage pole.

(1) Connect the test leads to the meter as follows

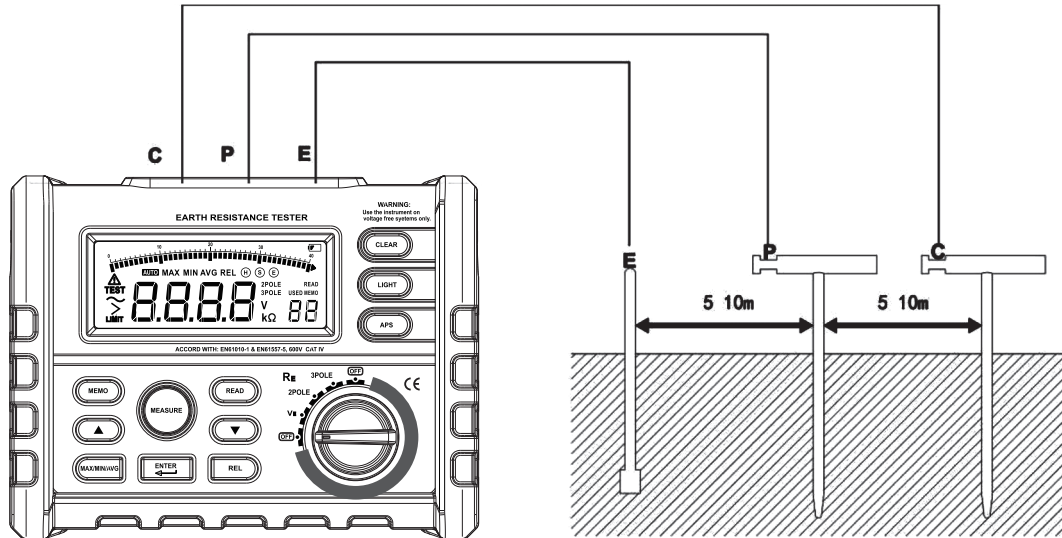

Drive deep the Auxiliary Earth Bars P, C in straight line into the ground and ensure that the bars are between 5 and 10 meters apart. Connect ends of the test leads (black, red and green) , which respectively from the ports E, P, C, separately to the object measured, auxiliary earth rod P and auxiliary earth C.

Attention: Drive the auxiliary rods where the earth is damp; in case that no other earth but clay, sand or gravel, which are dry, are available, spray some water onto them to keep them damp; in case the measurement is performed on a concrete floor, place the auxiliary earth rods horizontally and spray some water onto them or cover them with damp cloth.

(2) Measurement of earth voltage

Earth voltage measurement should be done before measurement of earth resistance to check the amount of earth voltage, as voltage more than 10 V is likely to cause larger error in the measurement of earth resistance. In this case, cut the measured object from the power supply and wait until the earth voltage drop for another measurement.

(3) Measurement of earth resistance

Rotate the switch to 3 POL position, press down the key of MEASURE to start the measurement, with the key LED turned on and glittering. When the measurement comes to the end automatically, the buzzer will give a sound, the key LED will go off and the data will be held automatically.

Attention: > LIMIT4000Ω displayed on LCD warns that the auxiliary earth resistance of the auxiliary earth rods is so high that the current can not flow across the meter. Check if the test leads become loose and the amount of the earth resistance of the auxiliary earth rods. In a measurement, test leads twisted together or becoming contacted each other will cause error in the measurement; therefore, make sure that a measurement is done when the test leads are separate. Besides, too much auxiliary earth resistance will bring unacceptable error to the measurement, therefore, respectively bury deep auxiliary earth rods such as P and C in too wet sites and ensure good connection in each joint.

4.4 Data Storage

The meter is capable of storing up to 100 groups of measurement data, which will not be lost even in case of power cuts

(1) When the meter is standing by, press MEMO to call the display for data storage, with "MEMO" glittering at the lower right corner of LCD; should the existing memory has been used for storage of other data, "USED" would be shown on LCD when pressing MEMO to exit data storage.

(2) Press "ENTER" briefly to switch A bit of a memory position and 10-bit and the memory position can be scanned by pressing "▼" or "▲" .

(3) Press "ENTER" for 2 seconds to store a group of data in a memory and in case that there are data stored before in the memory, the current data will cover the previous data.

4.5 Data Reading

Data reading function of the meter allows you to check the historical measurement stored in the meter.

(1) When the meter is standing by, press MEMO to call the display for data storage, with "MEMO" glittering at the lower right corner of LCD; should the existing memory has been used for storage of other data, "USED" would be shown on LCD when pressing MEMO to exit data storage.

(2) Press "ENTER" briefly to switch A bit of a memory position and 10-bit and the memory position can be scanned by pressing "▼" or "▲" .

(3) Press "ENTER" for 2 seconds to read a group of data in a memory if there are data stored before in the memory

4.6 REL—Relative Measurement

Relative measurement can be accessible only when the tester is used for measurement of earth resistance. Press REL to switch the relative measurement mode with the normal one or vice versa.

(1) Under relative measurement mode, the symbol "REL" is shown on LCD and the existing reading is stored in the memory for future reference. In the following relative measurement, what the LCD displays is the difference between the input value and the reference value, that is, existing reading=input value-reference value

(2) Under normal measurement of earth resistance, it is not allowed to enter REL mode when the measurement is progressing.

(3) It is not allowed to enter REL mode when the data is being read or stored.

(4) It is not allowed to enter REL mode when the existing reading exceeds the limit.

4.7 MAX/MIN/AVG Measurement

Press the key of MAX/MIN/AVG to switch the modes between the measurements of maximum, minimum, average and normal, corresponding to each of which a symbol is shown on LCD.

- (1) When MAX is selected, the LCD shows the maximum of all the data.
- (2) When MIN is selected, the LCD shows the minimum of all the data.
- (3) When AVG is selected, the LCD shows the average of all the data.

4.8 Data Deletion

The data can be deleted when READ or MEMO is pressed down. Press CLEAR briefly to delete the data stored in the existing position and press it long to delete all the data stored.

4.9 Backlight

Press LIGHT to turn on or turn off the backlight and it will go off automatically 15 seconds after it is turned on.

4.10 Auto off

Press ASP to start or cease Auto-off. The symbol  shown on the LCD means the Auto-off function has been started and disappearance of the symbol means that the function has been ceased. In case that no operation is performed within 15 minutes after Auto-off is on, the meter goes into sleeping status and the buzzer will give sound to remind of this . Press any key to wake the meter up. Be sure to set the switch to "OFF" if the meter will not be used for long.

5. Replacement of Batteries



Never replace the batteries while the meter is damp.

Never replace the batteries while the meter is being used. Switch off the meter and disconnect the test leads and earth rods before replacements to avoid electrical shock.



Never mingle new batteries with old ones.

Pay attention to the polarity of the batteries in replacements.

5.1 Unscrew the battery cover and remove it.

5.2 Replace the old batteries with new one and pay attention to their polarities.

5.3 Put back the battery cover and screw it.

